

Inertial Fusion Technologies 2023

Inertial Fusion Targets and Components

Precision Micromachined Components

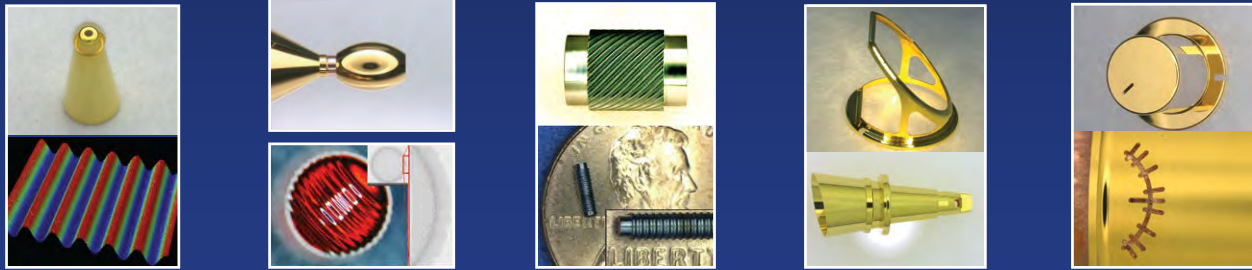

Sample of IFT Micromachined Product Line

Capsules – Glass, Polymer, Foam, Beryllium

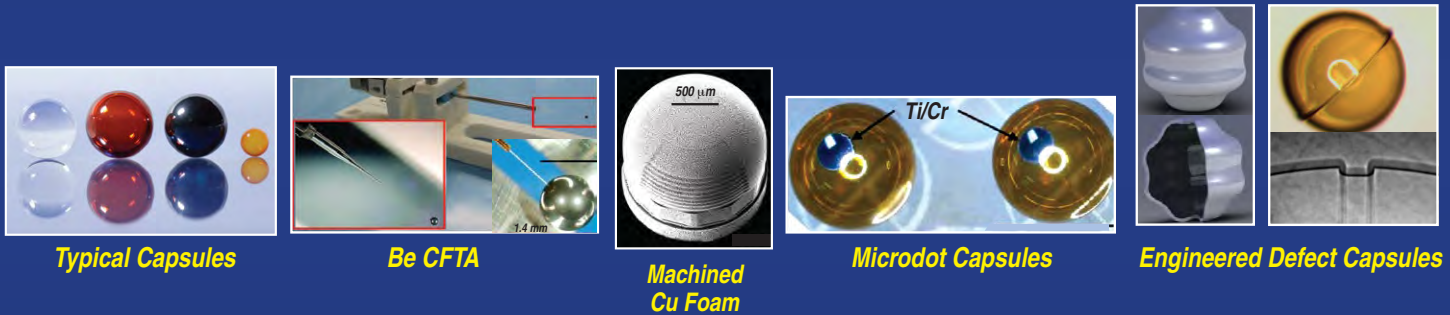

Typical Capsules

Be CFTA

Machined Cu Foam

Microdot Capsules

Engineered Defect Capsules

NIF Targets and Components



NIF Ignition Target

NIF Target Assemblies

Beryllium Shells

NIF Linerless DU Hohlräum

NIF Cryo Parts

Additive Manufacturing and Specialized Targets

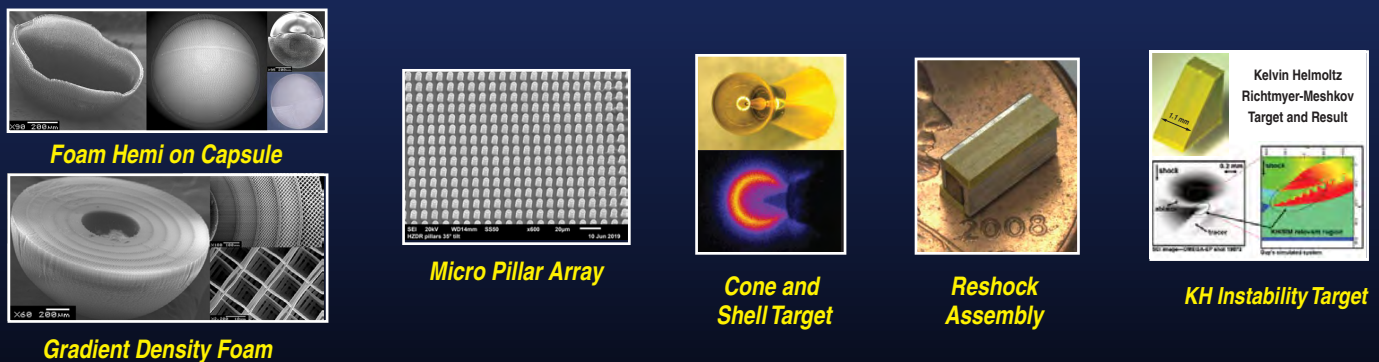

Foam Hemi on Capsule

Gradient Density Foam

Micro Pillar Array

Cone and Shell Target

Reshock Assembly

KH Instability Target

General Atomics Inertial Fusion Technologies (IFT) has provided targets, target systems, and target support services for the U.S. Dept. of Energy, Inertial Confinement Fusion Program since 1991. GA IFT supplies thousands of components each year for ICF experiments under its ISO9001:2015 Quality Management certification. On-time delivery is GA IFT's first quality objective, which it meets for over 10,000 components delivered each year. Quality and timeliness are key for the GA IFT Team.



What follows are examples of recent targets, and an overview of GA IFT capabilities followed by details in subsequent sections of this catalog.

NIF Rippled Be Capsules (LANL)

In a collaborative effort with Los Alamos National Laboratory, GA machinists using an improved technique machined and LANL EDM'd ripples into NIF scale beryllium capsules. Both LANL and GA target fab teams completed independent versions of the keyhole opening. The two capsule types were delivered to LLNL for assembly into HyGRA Keyhole targets.

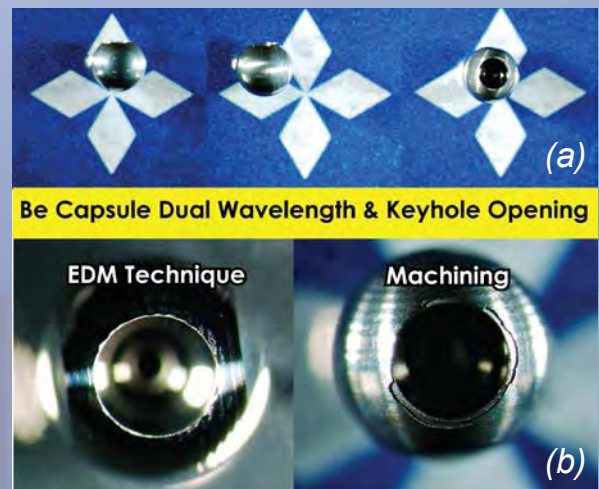

(a) Be capsule with dual wavelength and keyhole opening
(b) Result of EDM technique and GA machining method.

Patterned PAMS – Hydro Growth (HyGRA) Experiments

Machined PAMS Capsule Mandrel



GA staff imparted ripple patterns on PAMS mandrels for Hydro Growth Radiography experiments. This pattern is replicated on the inner surface of CH capsules. This technique provides an alternative fabrication path for Richtmyer-Meshkov (RM) and Rayleigh Taylor (RT) instability investigations.

Cone-in-Rippled Shell (LLE)

GA IFT machined various $< 10 \mu\text{m}$ amplitude ripple patterns to capsules and assembled the capsules to cones for LLE's Polar Direct Drive NIF experiments. Two axis radiography and surface interferometry techniques were used to analyze the patterns. The LLE scientists are using these targets to investigate laser imprint and shell perturbation implosion effects.



Optical image of ~2 mm OD test capsule with 7.8 μm amplitude ripple

Microdot Capsules for Evaluation of Plasma and T_e in LEH Hohraum Region (LLNL)

Metal microdot capsules have been fabricated to evaluate plasma conditions and electron temperature (T_e) in the hohlraum laser entrance hole (LEH) region. Metal co-mix alloys allow use of a streak camera diagnostic. To date co-mix microdots of Ti/Cr, Mn/Co, and discrete microdots of Mn and Fe have been deposited on capsules for LLNL experimenters.

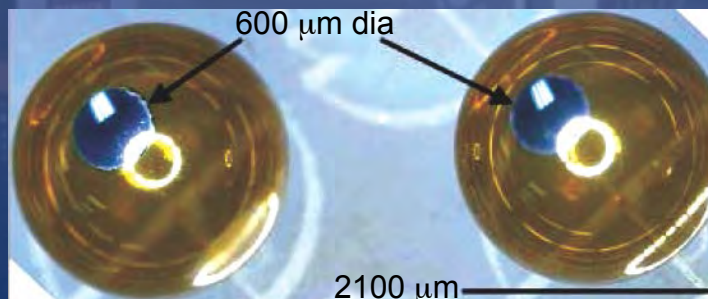

Ti/Cr alloy microdot capsules

Plasma Jet Targets (MIT)

GA designed and fabricated novel targets for MIT to investigate structure and dynamics of magnetic fields around plasma jets, and their effects on jet propagation. GA worked closely with the PI to ensure scientific objectives for the target were achieved while using additive manufacturing and laser machining. Use of 500 nm film on window openings and the gas fill made this target particularly challenging.

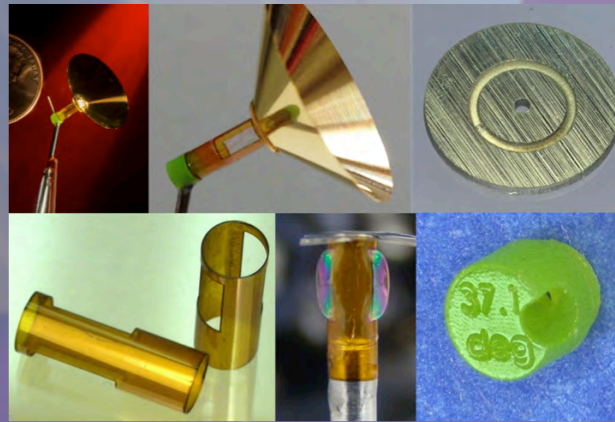

Plasma Jet targets and components

Be Rippled Rod for DMRT Experiments (SNL)

Beryllium machining advancements for Deceleration Magneto Rayleigh-Taylor (DMRT) experiments on Z have been accomplished. An innovative Be machining strategy was used to produce a ~4 to 1 (length to diameter) aspect ratio requested for Lincoln DMRT experiments. Final high aspect 4.5 x 1.2 mm solid Be rods were fabricated with wavelength = 300 μm , peak to valley = 60 μm and excellent surface finish.

*Be rippled rod for
SNL Z-machine
experiments*



Rippled-Diamond (HDC) Keyhole Capsules (LLNL)

GA IFT fabricated rippled-HDC keyhole capsules (fabricated by laser ablation) for Hydrodynamic Growth Radiography (HyGRa) experiments. These 2 mm diameter HDC, HyGRa keyhole capsules have $1.5\ \mu\text{m}$ peak to valley ripples at modes 60 and 90, covering one third of the capsule's surface.

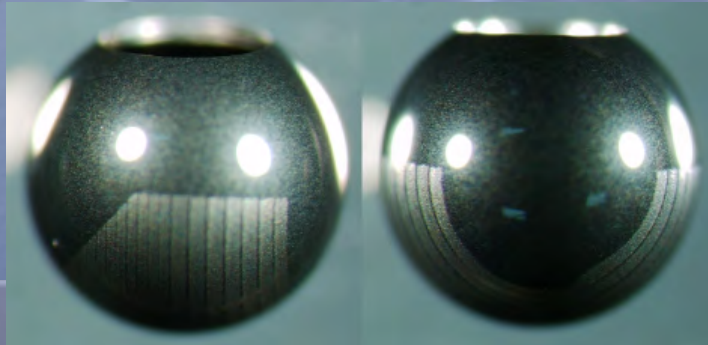

Capsule images with keyhole opening and machined patterns

Be Capsule Fill Tube Assemblies for Synergy Experiments (LANL)

GA has fabricated challenging and delicate sets of Beryllium CFTAs for Los Alamos Synergy experiments on OMEGA. These targets had Be capsules with a $\sim 1400\ \mu\text{m}$ OD and nominal wall thickness of 8 and $11\ \mu\text{m}$.

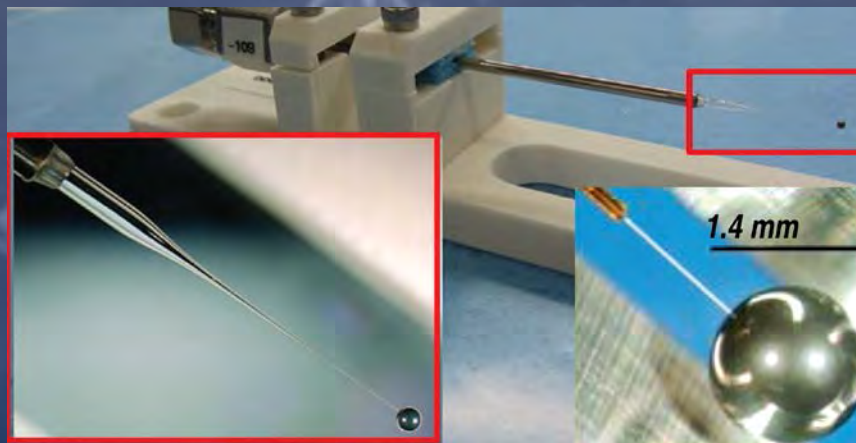

$\sim 1.4\ \text{mm}$ OD Be/Si/CH capsule on $30\ \mu\text{m}$ glass fill tube

ABEX Capsules (LANL)

In a collaborative effort with Los Alamos National Laboratory and GA, a set of challenging capsules were fabricated for the ABEX series of experiments on OMEGA. These experiments tested the effect of low mode asymmetry on implosion hydrodynamic and burn behavior in capsules. LANL machined low mode perturbations into PAMS beads provided by GA. After CH deposition, mandrel removal and Al coating, the desired defect capsules were then filled at Rochester or LANL and shot on the OMEGA facility.

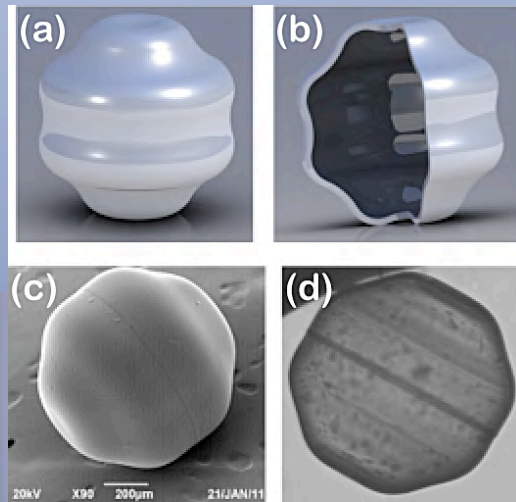

(a) ABEX capsule with large lobes. (b) cut away to show interior has same shape. (c) SEM micrograph of machined PAMS shell. (d) machined PAMS bead. ABEX Capsule diameter is approximately 1 mm.

RAYLEIGH TAYLOR Targets (NLUF) MIT

Thin polystyrene films with a sinusoidal pattern were fabricated for MIT's NLUF experiments to explore high fluid velocity instabilities with relevance to Super Novas and ICF targets.

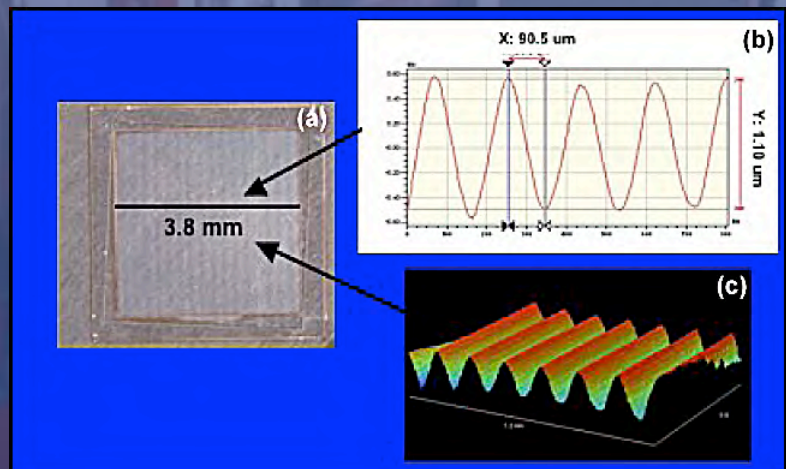

(a) heat pressed CH film with a sinusoidal pattern, (b) line out of the data, and (c) WYKO surface reconstruction from interferometric data.

MBOPac Targets (LLNL)

Multi-layer foils having sandwiched Ti, Ta, Fe, and/or Au layers were made using precision coating techniques. Foils were then characterized using a novel edge absorption x-ray method to determine areal density of the layer of interest. These precision foils were shot on OMEGA to study opacity for materials of interest.

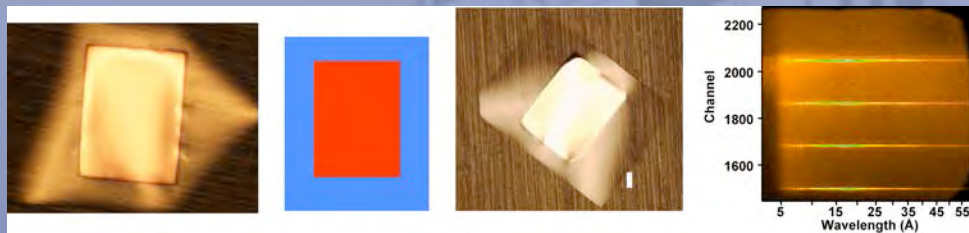

(a,c) Examples of patch targets. Patch is approximately $350 \times 450 \mu\text{m}$, with patch thickness $0.5 \mu\text{m}$. (b) Schematic of patch metallic multi-layer target. (d) Result from MBOPac experiment.

E-Coupling Targets (Fusion Science Center)

Multiple layer planar foils consisting of a fluorescent tracer layer with an embedded cone made of a different material such as Al or Au are fabricated as a single unit without a glue joint between layers. These targets are used to study the dependence of fast electron source production and energy transport on the cone tip material and cone guided alternative ignition target physics.

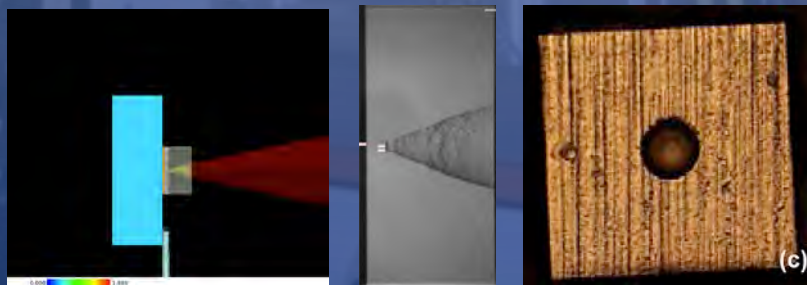

(a) Schematic of alternative ignition embedded cone target. (b) X-radiograph of embedded cone target. (c) View into center of cone. There is Al foil containing a 0.5 mm deep narrow and hollow conical indent with $\sim 30 \mu\text{m}$ diameter flat at the tip.

Kelvin-Helmholtz Targets (LLNL)

GA IFT rapidly brought up the capability to produce very sophisticated KH (Kelvin-Helmholtz) Instability targets for experiments on OMEGA. GA IFT made use of precision assembly equipment and expertise to fabricate these targets where a low density foam with a perturbed sinusoidal surface was mated to a high density plastic having a matching sinusoidal surface.

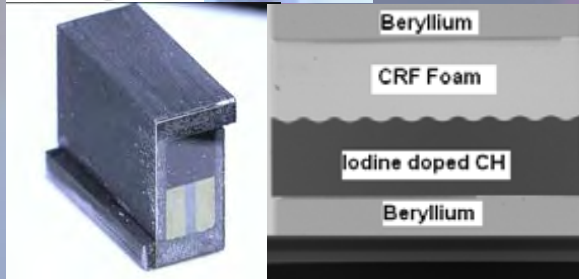
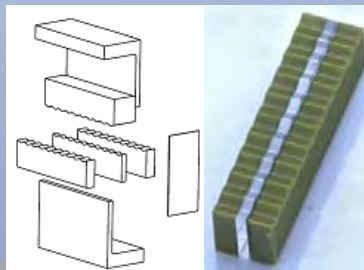

(a) Exploded view of target design (b) Polyamide-imide/CHI sandwich (c) Isometric view of assembled KH target (d) X-radiograph of low-density to high-density mated surfaces.

Alternative Ignition (NLUF) Cone-in-shell with Cu doped tracer layer

To better understand alternative igniter laser energy coupling to the imploded high density core, Au cone-in-(Cu-doped) CD shell targets were developed by GA IFT and have been used in integrated alternative ignition experiments. With Cu tracer in the imploded CD shell, the high intensity laser produced fast electron transport through the cone tip. High density and hot plasmas can be fully characterized by measuring the induced characteristic Cu K-shell x-radiation.

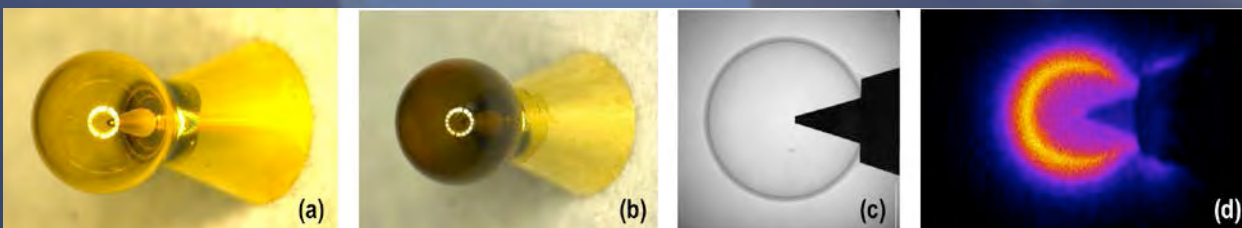

(a) Un-doped Cone-in-Shell Target (b) Cu-doped Cone-in-Shell Target (c) X-ray image of Target (d) Experimental result showing Cu K-shell x-radiation from shot

DIME Capsules (LANL) Defect Implosion Experiment

CH shells with deeply buried Ti doped tracer layers made at GA have been used to study mix during implosion for some time. GA has extended this work to include shells with micro-machined equatorial trenches designed by Los Alamos National Laboratory to investigate mix during implosion. Shells were coated with a permeation barrier to allow filling with DD or DT for the shots.

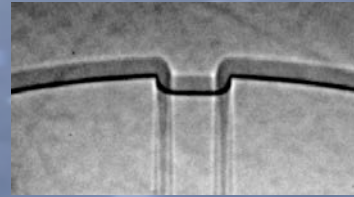
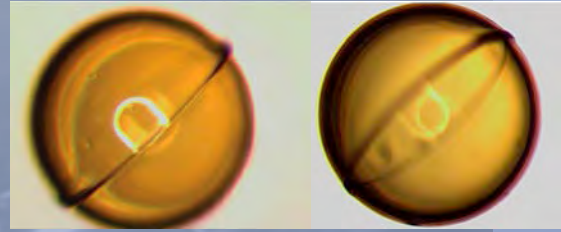

(a,b) images of 1 mm diameter shells with trench defects containing Ti doped tracer layer and (c) radiograph showing cross section of trench defect.

Ross Pair Filters (thin Ge on Graphite) for NIF Diagnostics (LLNL)

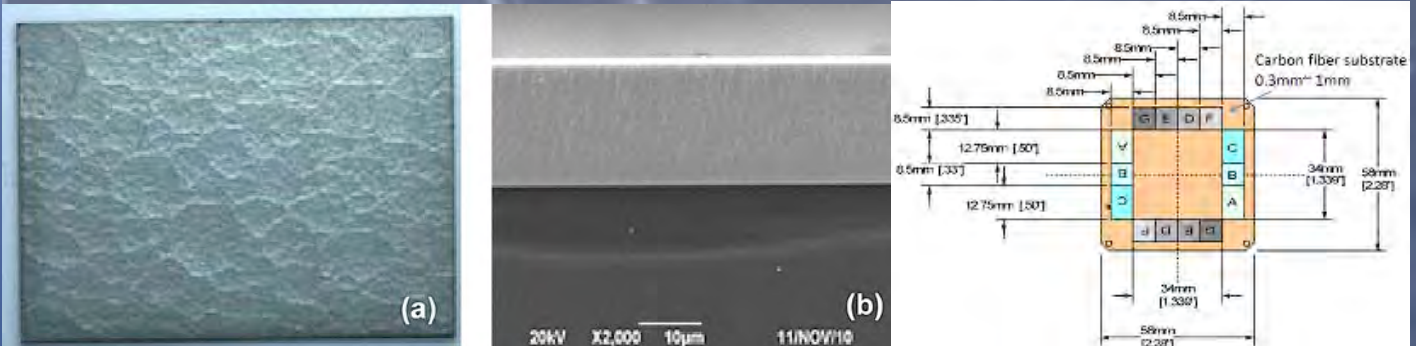

(a) Deposited Ge surface of a 8.5 mm x 12.75 mm foil. (b) SEM micrograph of Ge/C interface showing Ge film uniformity. (c) Schematic for Ross filter assembly pattern.

As part of diagnostic development at NIF, LLNL procurement sought providers that could supply uniform Ge coatings on substrates. GA IFT engineers developed an electron beam coating process to obtain 24 to 50 μm thick Ge films and successfully coated these films uniformly on Si and C (graphite). GA IFT delivered 20 Ge-graphite and 80 Au-graphite foils to LLNL used in GXD and hGXI diagnostics for NIF.

CHaRM (CH ablator Richtmyer-Meshkov) Targets (LANL/LLNL)

GA IFT produced engineered defect array targets and stepped targets for the National Ignition Campaign CHaRM series of experiments. The purpose of CHaRM experiments is to quantify ablator drive from shock speed determination and to determine ablative RM growth on CH ablators at long pulse durations. The targets were also used to determine the effect of initial bump width on growth to improve EOS modeling.



(a) CH flat foil target with square array of bumps. (b) Bumps are nominally 12 μm tall, 25 μm FWHM, and spaced 125 μm apart on a 60 μm thick CH disk. (c) Experimental radiograph from OMEGA shot.

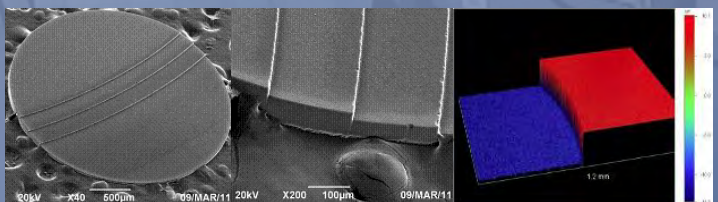

(a,b) CH foil target with multiple 20 μm steps (c) white light interferometry reconstruction of step and surfaces.

FeK Shell Target (1 to 3 μm Cylindrical Fe Coating) (LLNL)



(a) Side view of FeK Shell Target Cylinder. Cylinder is approximately 4 mm in length and diameter. SS-304 (70 atom% Fe) coating was deposited inside 50 μm wall thickness epoxy. (b) Cross-section of cylinder with Fe coating. (c) High magnification of wall cross-section showing thin Fe inner layer.

FeK shell targets were used for x-ray source development to understand K shell emission from iron.

Cone (Cone and Foil) Targets (Fusion Science Center)

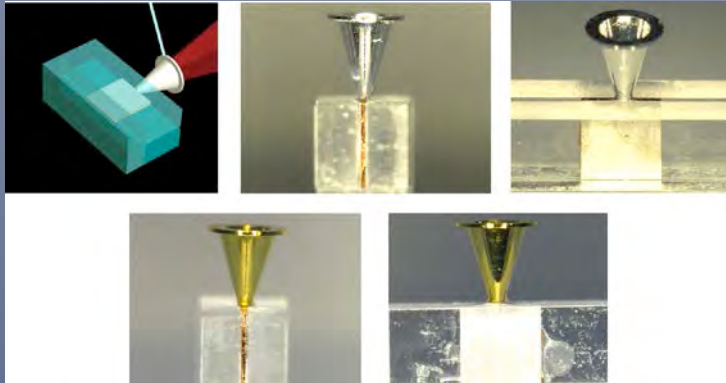

(a) Schematic of Cone and Foil Target. (b) Al Cone and Cu Foil Targets. (c) Au Cone and Cu Foil Targets.

The purpose of cone (Al or Au) attached to Cu wire or Cu foil (buried in plastic) target experiments is to study alternative ignition relevant high intensity laser produced electron beam source characteristics, such as laser to fast electron conversion efficiency, fast electron temperature, and angular divergence. In addition, these experiments also investigate the dependence of fast electron source characteristics and energy transport through the cone tip on the cone material.

Lead (Pb) Hohltraums

(a) Pb halfraum on mandrel. (b) Pb halfraum with LEH. (c) Pb halfraum with LEH and diagnostic hole.

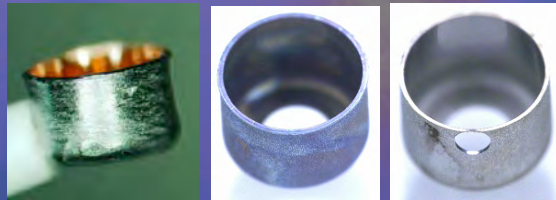

Experiments to characterize the performance of Pb hohlraums were successfully conducted on OMEGA. To support these experiments GA IFT staff investigated 3 paths to hohlraum fabrication and ended up using a Pb plating process. This technique is flexible so prototyping other hohlraum shapes like “rugby” is relatively fast. Experimental results demonstrated that Pb is energetically comparable to Au.

NIF Target Assemblies

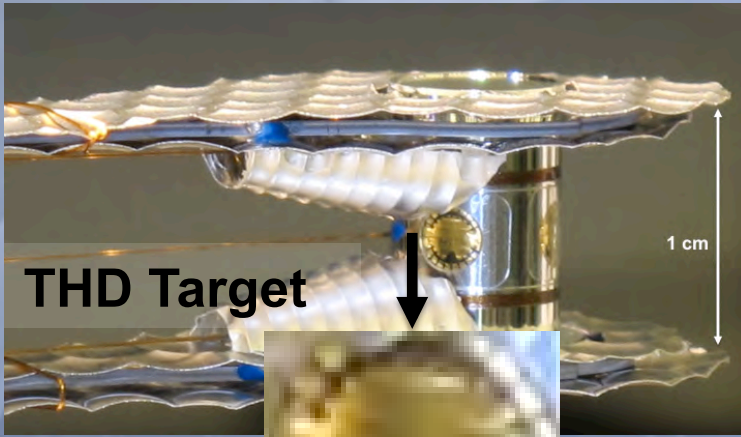

GA IFT fabricates
majority of
target
components
used by NIF



Re-Emit
Target

A photograph of a Re-Emit Target, which is a cylindrical target component. A black arrow points from the text 'Re-Emit Target' to the target.

Convergent Ablator Target



NIF Target Assemblies

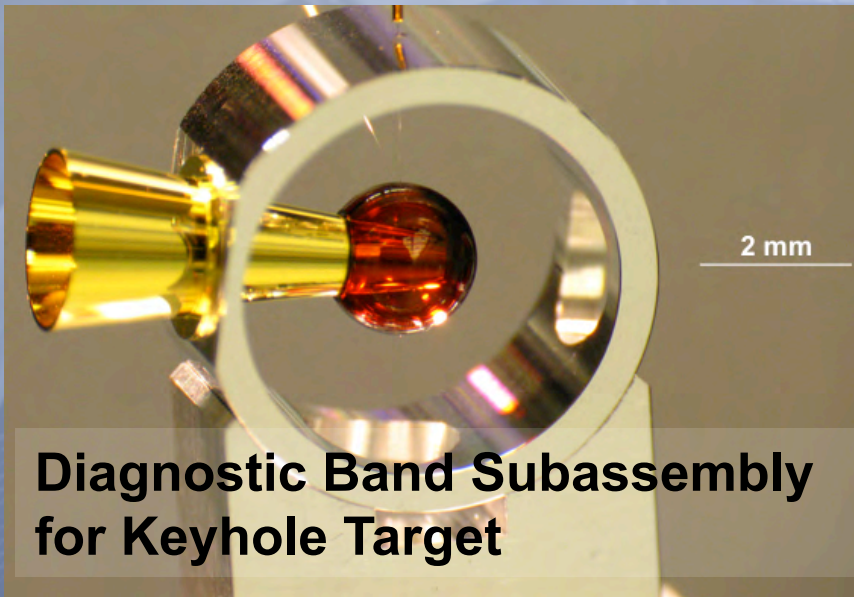

**Diagnostic Band Subassembly
for Keyhole Target**

**GA IFT
fabricates
majority of
target
components
used by NIF**

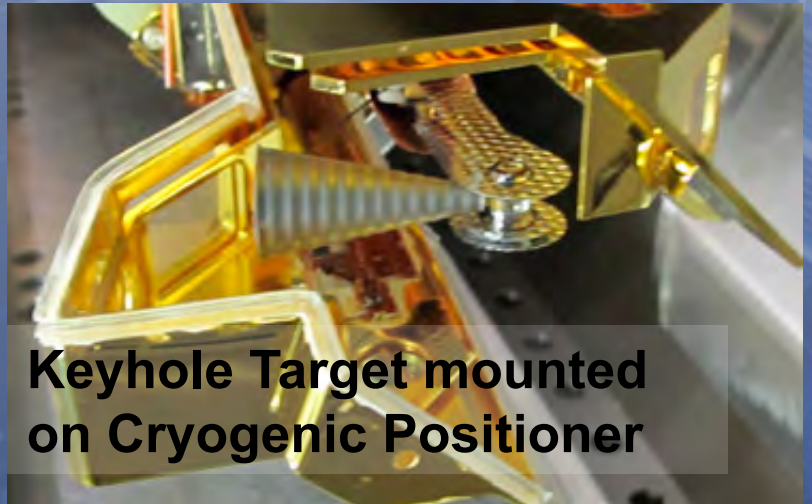

**Keyhole Target mounted
on Cryogenic Positioner**



**Keyhole Target viewed
inside Cryogenic Shroud**

PRODUCTS AND SERVICES FROM GENERAL ATOMICS INERTIAL FUSION TECHNOLOGIES

1. GENERAL INFORMATION

Mike Farrell
Vice President, Inertial Fusion Technologies
michael.farrell@ga.com
858-455-3975

Neal Tomlin
Deputy Director, Inertial Fusion Technology
neal.tomlin@ga.com
858-455-2982

Paul Fitzsimmons
Fabrication Deputy, Inertial Fusion Technologies Target Production
paul.fitzsimmons@ga.com
858-455-2052

2. PRECISION MACHINED COMPONENTS

Mike Mauldin
Center for Precision
Manufacturing
Michael.Mauldin@ga.com
858-455-3118

- High Precision Micro-Machined Targets and Components
 - Electroplated gold
 - Hohlräume
 - Fast Ignition Targets

3. POLYMER, GLASS, BERYLLIUM, COMPOSITE, AND MULTI-LAYERED CAPSULES

Claudia Shulberg
Center for Direct Drive Capsule Production
claudia.shulberg@ga.com
858-455-2605

- Direct and Indirect Drive Capsules
 - Designed Defect Capsules
 - Diagnostic layers
 - Diagnostic and Fuel Gases

Mark Ratledge
Beryllium Coating and NIF Capsules
mark.ratledge@ga.com
858-455-3850

- Beryllium Capsules
- NIF Plastic Capsules
- NIF Capsule Characterization

4. COATINGS FOR SPECIALIZED ICF TARGETS

Loosineh (Lucy) Aghaian
Center for Metal Coatings
loosineh.aghajian@ga.com
858-455-3091

- Metallic and Organic Coatings
 - Atomic Layer Deposition
- Plasma Enhanced Chemical Vapor Deposition
 - Chemical Vapor Deposition

5. CHEMISTRY AND FOAM FABRICATION

Wendi Sweet
 Center for Foams and Materials
 wendi.sweet@ga.com
 858-455-3386

- TPX, Polystyrene, Divinyl Benzene, Resorcinol Formaldehyde (RF) and Carbonized RF Targets for Z
 - Doped Foams
 - Foams with Embedded Objects

Fred Elsner
 Center for Chemistry, Polymer, and Foam Development
 fred.elsner@ga.com
 858-455-2977

- RF Foam Flats and Capsules
 - Silica Aerogels
 - Organic Foam Targets
- Cast and Machined Foams

6. LASER MACHINING

Travis Nunn
 Center for Laser Machining
 travis.nunn@ga.com
 858-455-4323

- Specilized Target Forming and Laser Cutting
 - Pinhole Diagnostic Components
 - Resolution Grids
 - X-ray Neutral Density Filters
- Fill Tube Fabrication and Joining

7. NATIONAL IGNITION FACILITY (NIF) TARGETS AND COMPONENTS

Mark Ratledge
 Center for NIF Targets
 mark.ratledge@ga.com
 858-455-3850

- Capsule Fill Tube Assemblies
 NIF Capsules

Jared Hund
 NIF Targets and Components
 jared.hund@ga.com
 858-437-1561

Mike Mauldin
 NIF Micro-Machined Components, Center for Precision Manufacturing
 Michael.Mauldin@ga.com
 858-455-3118

- NIF Hohlräume
- Thermo-Mechanical Packages
- Cones, Dagnostics Bands, LEHs, Washers, Windows
 - TMP Sub-Assemblies

8. METROLOGY AND CHARACTERIZATION DEVELOPMENT

Haibo Huang
Center for Characterization Innovation and Development
haibo.huang@ga.com
(858) 455-4152

- Precision X-Radiography
- Quantitative X-Radiography for Composition and Metrology
 - Spheremapper/Wallmapper
 - Interferometry
 - Ellipsometry of Thin Films
- Development of Characterization Methods

9. PRECISION TARGET ASSEMBLY

Travis Nunn
Center for Precision Target Assembly
travis.nunn@ga.com
858-455-4323

- High Precision Target Assembly
- NIF, OMEGA, OMEGA EP, Z-Facility Assembly and Characterization

10. ADDITIVE MANUFACTURING

Fred Elsner
Two-Photon Polymerization, Aerogel and Foam Research
fred.elsner@ga.com
858-455-2977

TABLE OF CONTENTS

INTRODUCTION AND BACKGROUND

1. SUMMARY AND CAPABILITIES	1-1
2. PRECISION MACHINED COMPONENTS	2-1
Micromachining Capabilities	2-1
Equipment	2-1
Metrology	2-1
Cylindrical Components	2-1
Planar Components	2-2
Patterned Surfaces	2-2
Targets for Astro-Physical Experiments	2-2
Product Line of Micromachined Components	2-3
Unique Micromachined Components	2-5
3. CAPSULES	3-1
Polymer Capsules	3-1
GDP Shells	3-2
Drop Tower	3-3
High-Z Doping of Glass Shells	3-4
Beryllium Shells	3-4
Foam Shells	3-6
Polyimide Shells	3-6
Specialty Shells and Targets	3-7
Gas Fills and Half-Life Measurements	3-7
Nonpolymeric Coatings on Shells	3-8
4. COATINGS FOR SPECIALIZED ICF TARGETS AND COMPONENTS	4-1
Coating Capabilities	4-1
Equipment	4-1
Multi-Layer "Cocktail" Coatings	4-2
GA-Built Glow Discharge Polymer (GDP) Coating Systems	4-3
Atomic Layer Deposition Coatings	4-4
5. CHEMISTRY AND FOAM FABRICATION	5-1
Resorcinol Formaldehyde (RF) Aerogel	5-2
Silica Aerogel	5-3
TPX	5-3
Composite Plastic/Foam Planar Targets	5-5
Microwire Backlighters	5-6

6. LASER MACHINING	6-1
Laser Machining Capabilities	6-1
7. NIF TARGETS, COMPONENTS, DIAGNOSTICS	7-1
NIF Capsules	7-2
NIF Hohlräume	7-2
NIF Diagnostics	7-3
8. METROLOGY AND CHARACTERIZATION DEVELOPMENT	8-1
Geometry and Material Properties	8-1
Contact Radiography	8-2
Energy Dispersive Spectroscopy (EDS)	8-2
X-Ray Fluorescence (XRF)	8-2
White-Light Interferometer	8-2
Spheremapper	8-3
Whole Image White Light Interferometry (WYKO)	8-3
Optical Microscopy	8-3
Automated Microscopy	8-3
Wallmapper (Transparent Capsules)	8-4
Absorption Edge Spectroscopy (Edge)	8-4
Precision Radiography	8-4
Phase Shifting Diffraction Interferometer (PSDI)	8-5
Xradia Wallmapper (Transparent and Opaque Capsules)	8-5
FTIR Spectroscopy	8-6
Densitometry	8-6
Auger Spectroscopy	8-6
Scanning Electron Microscopy with EDX	8-6
Thermogravimetric Analysis (TGA)	8-6
Ellipsometry	8-7
Gas and H ₂ O Permeability	8-7
9. PRECISION TARGET ASSEMBLY	9-1
GA-Built Dual Theta Assembly/Characterization Station	9-2
10. ADDITIVE MANUFACTURING	10-1

1. SUMMARY OF CAPABILITIES

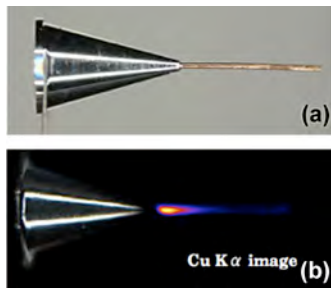

(a) Cone and wire target. (b) Experimental result from shot.

Our targets and components are produced by combinations of micro-machining and chemical processes such as electroplating and physical vapor deposition. Dimensions are controlled to 1 μm with surface roughness to less than 2 nm RMS. We can produce conventional and specialized hohlraums, witness plates, sine-wave plates, and Z central cans. We have fabricated a variety of NIF targets and components as shown in the earlier sampling, and other complicated ICF components. The parts can be coated with pure and doped CH, various metals, and insulators.



Shock timing cone and shell target.

Polymer, glass, and beryllium microshells are currently the main types of capsules in the ICF program. We can supply polymer shells ranging from full density to ultra-low density foams in diameters up to 5 mm and wall thicknesses from a few micrometers to several hundred micrometers. The shell walls can consist of many layers that can be doped with a variety of elements. Permeability to various gases can be controlled by fabricating capsules with coatings having low permeability. This allows us to produce capsules with many types of gas fills.

Similarly, we can supply glass shells at diameters over 2 mm filled with a variety of gases. The surface finish of our microshell capsules is generally less than 5 nm RMS.

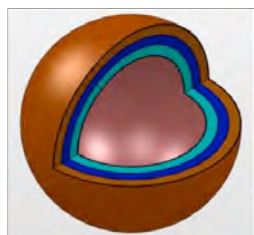

Schematic of multi-layer plastic capsule. Coating layers can be doped with Si, Ge, Ti, Cl, Cu, or D.

We can supply beryllium shells over a range of diameters from 440 μm diam Nova-type capsules to 2000 μm diam NIF-type capsules. Wall thickness can vary from less than 5 μm to over 160 μm . Surface finish depends on the wall thickness. For a 5 μm thick beryllium shell, the typical surface roughness is less than 50 nm RMS.

For a thicker layer, mechanical polishing is available to reduce the surface roughness to very low levels (<5 nm RMS). Beryllium shells can include dopants such as copper. Profiled doping has been demonstrated.

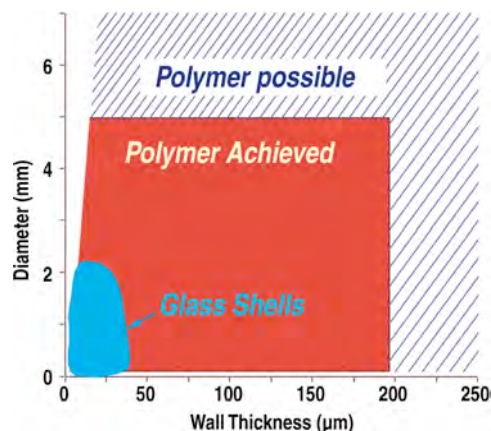

We have the capability to make multi-element “cocktail” hohlraums. A typical multi-layered cocktail coating targeting composition of 75 at. % depleted uranium and 25 at. % gold, for example, consists of repeated multi-layers of 30 nm depleted uranium and 8.2 nm gold. We can also fabricate uranium and lead hohlraums. For uranium hohlraums, several microns of gold are sputtered onto the uranium coating to protect it from oxidation.

Planar targets can include layers of polymers, foams, metals, oxides, salts, and other materials. Patterns can be imposed including sine waves of various amplitudes and wavelengths, square waves, and two-dimensional sine waves. Planar targets are generally mounted on a frame.

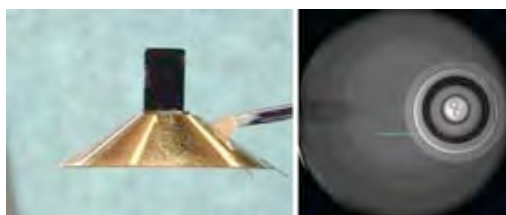

OMEGA foam Astroshock target. Radiograph shows embedded spheres.

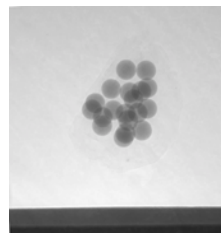

Side view radiograph R/F foam target with suspended sphere clump.

A variety of foams can be fabricated for targets with several types of polymers having densities from 850 to 3 mg/cm³, some with submicron cell sizes. The foams can be cast or machined into custom shapes and may include an embedded capsule.

We characterize key properties of the targets and components we deliver. When our characterization is complete, we not only confirm that an item meets the specification, but that it has a pedigree with traceable and certified measurements. A wide variety of standard characterization techniques are used including manual and automated optical microscopy, SEM, EDXS, interferometry using WYKO, x-ray fluorescence, FTIR, densitometry, ellipsometry, and contact radiography.

Advanced characterization techniques we developed and use for target metrology include custom White-Light Interferometry, Absorption Edge Spectroscopy, Precision Radiography, Phase Shifting Diffraction Interferometry (PSDI), AFM Wallmapper and Spheremapper, and Xradia Wallmapper.

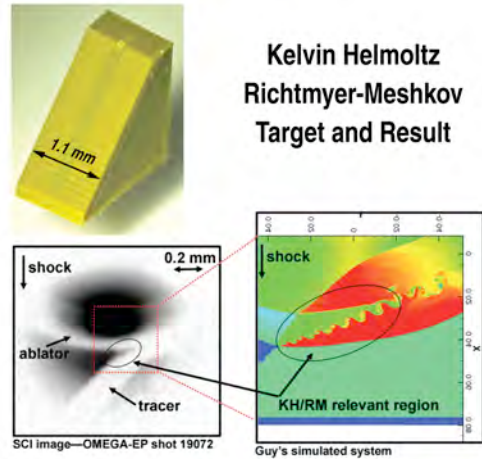

University of Michigan, KH instability target

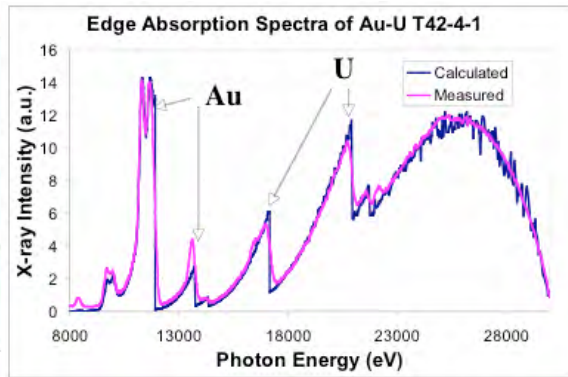
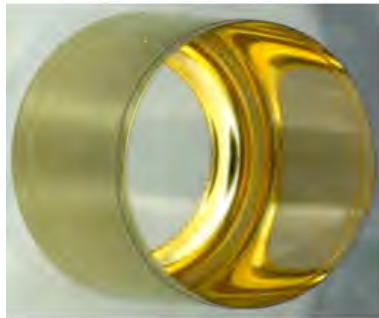

Edge Absorption Spectroscopy used to measure Au and U thicknesses in NIF cocktail hohlraum.

We also produce custom built or modified equipment used for target fabrication and target handling. These include glow discharge polymer (GDP) coating systems for CH and doped CH coating, the spheremapper/wallmapper for measuring the surface finish and wall thickness of capsules, and a dual theta assembly/ characterization station for targets that are fielded in spherical chamber, cryogenic target systems.

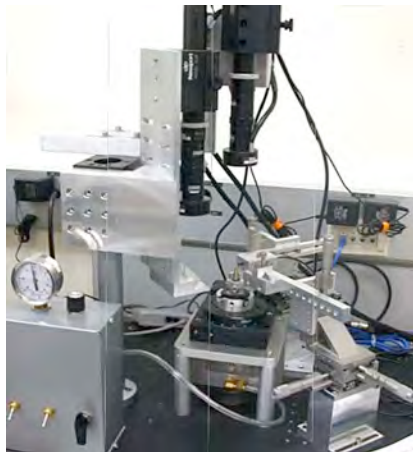

Spheremapper/Wallmapper.

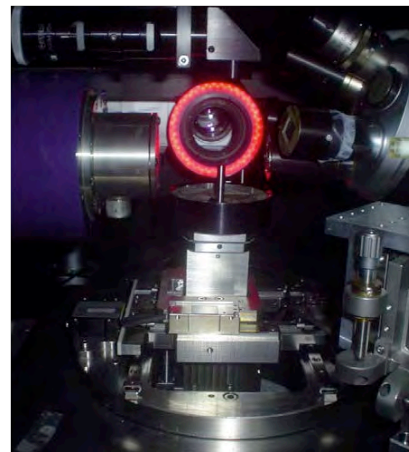

Xradia Tomography System.

2. PRECISION MACHINED COMPONENTS

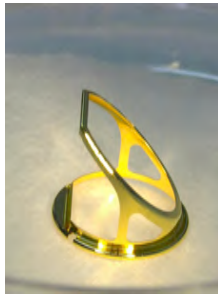

Au NIF mirror mount.

MICROMACHINING CAPABILITIES

The General Atomics IFT team can provide a variety of high-precision micromachined components on a production or development basis.

We can supply millimeter and sub-millimeter sized components of different shapes micromachined from a variety of materials.

Components can be made to tolerances within $\pm 1 \mu\text{m}$ and with a surface finish better than 10 nm RMS.

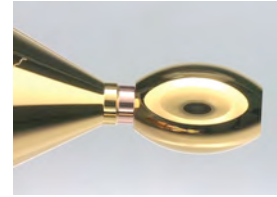

Rugby hohlraum.

EQUIPMENT

GA has six Precitech and four Moore diamond turning machines.

There is slow-tool servo and fast-tool servo capability on two of our diamond turning machines.

We have three 5-axis KERN micromill machines.

We have the capability to machine uranium, beryllium, and lead.

METROLOGY

Quality control and certification are achieved with the use of:

- Z-Mike laser micrometers
- Nikon microscope measuring systems
- WYKO surface profilers
- DekTak surface profilers
- ZYGO laser interferometer
- Interference microscopes
- JEOL scanning electron microscope with EDAX
- Confocal microscope
- Dual Confocal microscope



CYLINDRICAL COMPONENTS

GA fabricates complicated cylindrical components in a number of materials with high precision.

GA produces a wide variety of hollow cylindrical gold components.

Hollow cylindrical components are made in three steps involving micromachining of a copper mandrel, electroplating the mandrel, and then etching away the mandrel.

We can produce cylindrical components with complex patterns, such as sine wave patterns, around the circumference of the cylinder.

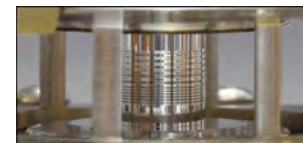



PLANAR COMPONENTS

GA IFT can fabricate complex planar components and foils with multiple layers from a variety of materials.

Plates have been fabricated ranging in size from a few millimeters to as small as a few hundred microns square.

These plates measure in thickness from 5 to 300 μm and have been constructed of aluminum, copper, Kapton, polystyrene, polyimide, and GDP.

The variety of plates include flat plates, stepped plates, wedge plates, and plates with sine waves machined in them. Patterns such as $\sin(x) \sin(y)$, and more complex patterns, have been machined into plates.

Using PVD of different materials, bimetallic witness plates have been fabricated.

PATTERNED SURFACES

Patterns can be machined into target surfaces using a precision single-point diamond turning lathe. Most requested patterns are sine waves, but complex patterns including sine waves with overtones, multiple patterns on the same target, and $\sin(x) \sin(y)$ patterns can also be made.

TARGETS FOR ASTRO-PHYSICAL EXPERIMENTS

We have the capability to machine and assemble a variety of complex targets for astrophysical experiments. Some examples have been BlastWave, SNRT, and Astros shock targets for NLUF experiments.

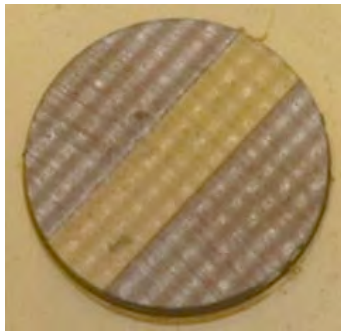

Fabricated SNRT pattern.

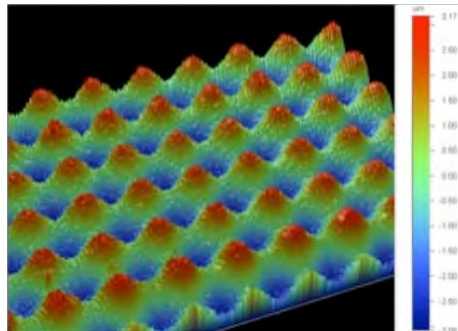

Measured SNRT pattern.



Micromachined BlastWave target.

PRODUCT LINE OF MICROMACHINED COMPONENTS



PRODUCT LINE OF MICROMACHINED COMPONENTS (CONTINUED)



UNIQUE MICROMACHINED COMPONENTS

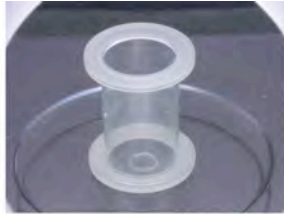

Epoxy hohlraum

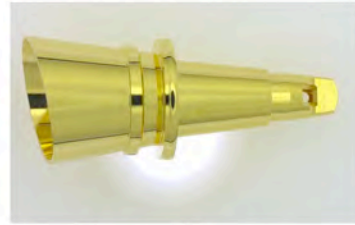

Visar keyhole cone

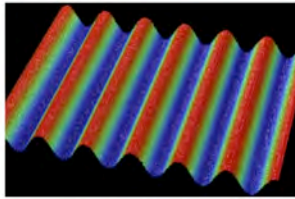

Foil with sine wave surface



Radiation mask

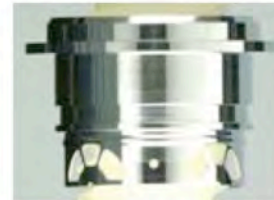

NIF TMP aluminum can

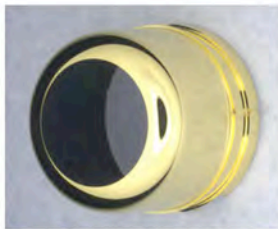

NIF linerless DU hohlraum



Shock timing cone and shell target



Rugby Au halfraum



Gold cylinders and flanges



NIF diagnostic band



Thin wall (1 μ m) hohlraum



Lead hohlraums



3. CAPSULES

The General Atomics IFT Team produces a variety of microshells for use as targets for various laser facilities around the world. These include glass, polymer, foam, and beryllium shells.

POLYMER CAPSULES

Many of the polymer capsules produced for laser shots are made using the depolymerizable mandrel technique. This is a three-step process as illustrated below. The starting mandrel is a poly(α -methylstyrene) (PAMS) shell produced by microencapsulation. The PAMS shells are then coated with GDP (or polyimide if desired), which is thermally stable at 300°C. When the GDP-overcoated PAMS composite shell is heated to 300°C, the PAMS mandrel decomposes into a vapor and is permeated out of the GDP coating. The PAMS polymer decomposes into its monomer form at 300°C. This leaves behind the GDP coating as the final shell material. The process has the advantage of allowing fabrication of thin, thick, doped or undoped shells, as well as shells containing a sandwiched doped layer placed virtually anywhere within the shell wall by simply adjusting the coating. Various types of shells produced using this technique are presented.

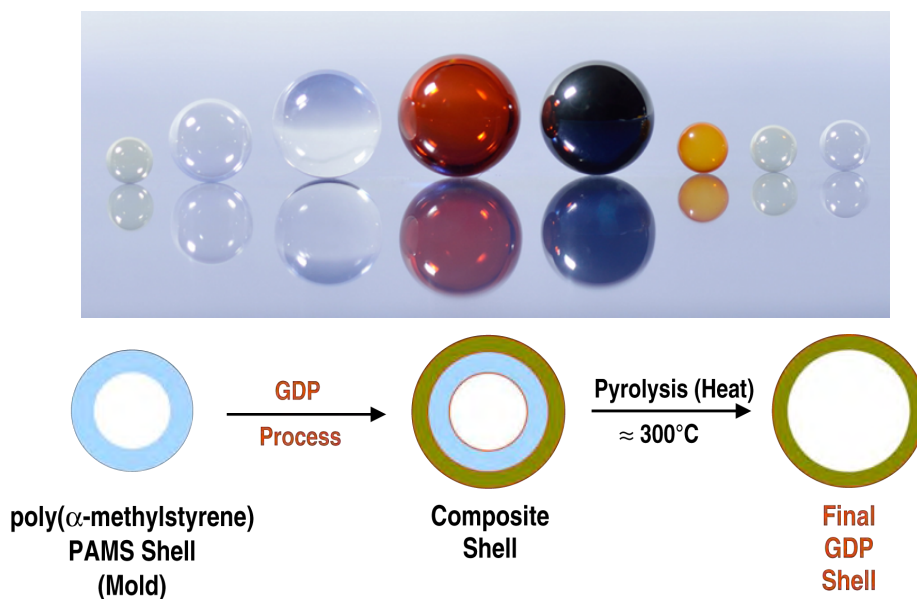

PAMS shells are fabricated using the microencapsulation process. This technique uses the immiscibility of oil and water to initially produce liquid shells of polymer material dissolved in oil-like solvent. Upon proper curing and drying, solid polymer shells with excellent wall uniformity (<5%) can be made from ~200 μm to over 5 mm in diameter.

While these shells are usually used as the starting mandrel for GDP or polyimide shells, they can be used as the target material depending on the application. For example, PAMS shells are currently used as the inner mandrel for Nova-type capsules.

PAMS shells can be made with very good wall uniformity, when the wall thickness is about 10%–20% of the diameter. The capability to produce thick-wall PAMS shells is not limited. Thicker shells can be fabricated having acceptable wall uniformity with slightly less yield.

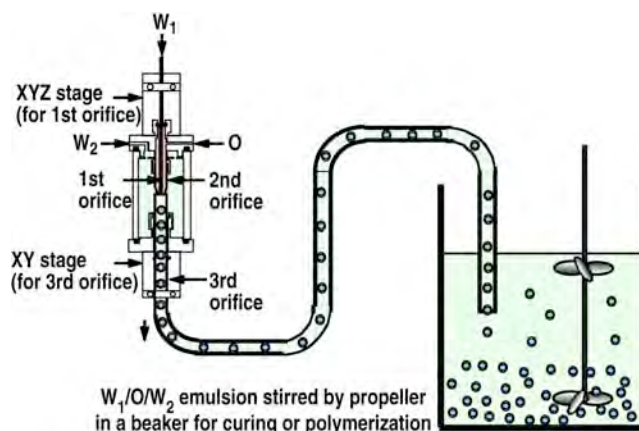

Scaling to a mass manufacturing process allows these shells to be available in large quantities.



Vials of mass-produced PAMS shells.

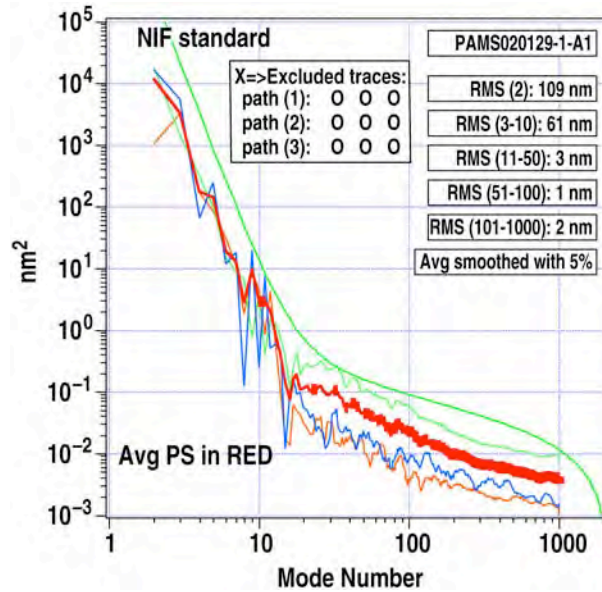

Typical PAMS shell power spectra.

GDP Shells

Glow discharge polymer (GDP) capsules are made by over-coating PAMS shells with GDP then pyrolyzing away the PAMS mandrel. GDP is a plasma polymer. Depending on the coating conditions and the process gas(es) used, the GDP coating, which is the eventual ablator material, can be composed of various materials which are CH based. The table that follows lists the materials currently deposited by GA.

The materials listed can be deposited in various combinations to produce shells containing several different layers each containing a different composition. These targets have been used in a variety of ICF experiments. Extensive examination of various combinations of materials indicated that the layers do not delaminate from each other; hence, the shell wall is contiguous.

The surface finish of these coatings is typically below 10 nm RMS for the types of materials listed in the table.

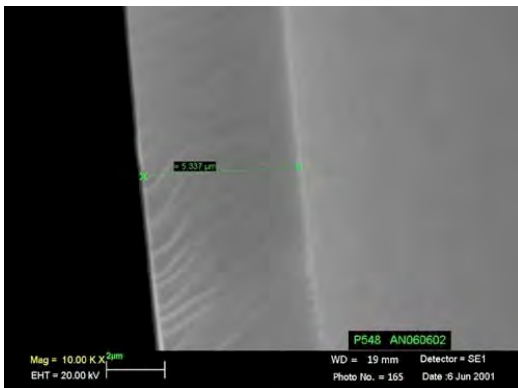

SEM of GDP coating on shell.

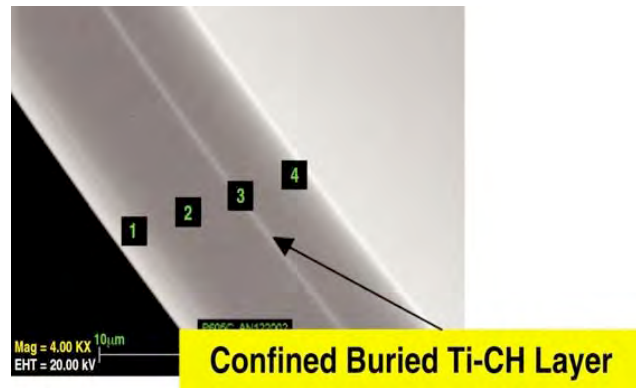

Material/Dopant	at. % Range	Comments
CH	NA	“Strong” CH available
CD	NA	“Strong” CD available
Si-CH	Up to 6%	
Ge-CH	Up to 6%	
Ti-CH	Up to 5%	Ti is TiO in layer
Cl-CH	~6%	Only in outer layer
Ti-Cl-CH	Up to 3% Ti, 3% Cl	Only in outer layer
Cu-CH	~1%	

Glass capsules can be made using two different techniques. The first utilizes a heated drop tower, while the second involves a silicon-doped glow discharge polymer (Si-GDP) coating. A range of diameters and thicknesses can be produced using each technique. The details are given here.

Drop Tower Glass Shells

Drop tower glass shells are fabricated by dropping specially formulated frit through a high temperature (up to 1650°C) ceramic tube several meters in length. Glass shells with different compositions including pure SiO₂ or glass doped with boron, calcium, sodium, rubidium, and potassium can be manufactured using this technique. These shells have good wall uniformity (<5%) for the smaller diameter sizes ($\leq 600 \mu\text{m}$). However, for larger sizes, the wall uniformity becomes progressively worse. In addition, shells larger than $\sim 1300 \mu\text{m}$ in diameter cannot be produced using the current tower. Shells made using the drop tower technique contain about 0.25 atm of residual gases consisting primarily of CO₂, water vapor and air – some of which, like water vapor, can be removed by additional baking.

Large batches of shells ($\sim 100\text{s}$) are produced quickly using this technique.

Drop Tower Glass Shells

Diameter Range (μm)	Wall Thickness Range (μm)
100 – 300	0.5 – 30
300 – 600	1 – 20
600 – 900	2 – 10
900 – 1200	2 – 5



Glass drop tower.

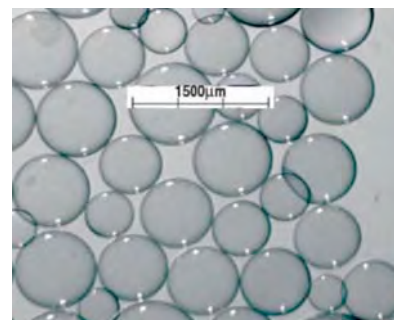

Fabricated glass shells.

Hoppe Glass Shells

Si-GDP glass shells using the Hoppe Glass Shell technique are fabricated by first producing a Si-GDP shell using the depolymerizable method. The Si-GDP shell is then oxidized in air, thereby converting the silicon into SiO_2 and removing the carbon and hydrogen in the shell by conversion to CO_2 and water vapor. The resulting pure silica shell contains about 0.25 atm nitrogen, 0.05 atm CO_2 , and trace amounts of CO and argon. These capsules have excellent wall uniformity and power spectra over all size ranges.

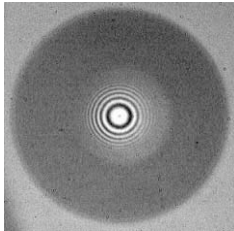

Interferometric view of 440 x 35 μm Si-GDP shell indicating near-perfect wall thickness uniformity.

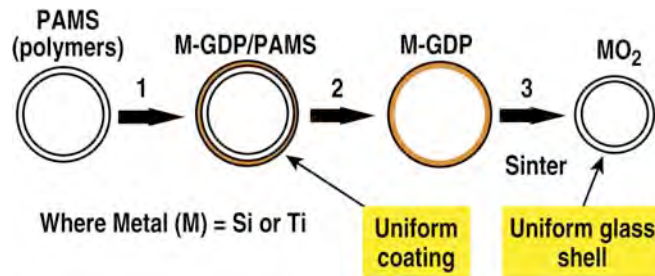

Hoppe Glass Shells

Diameter Range (μm)	Wall Thickness Range (μm)
250 – 500	2 – 35
500 – 1000	1 – 20
1000 – 2000	5 – 20

In addition, we developed the Si-GDP glass shell fabrication process to make shells containing Hi-Z diagnostic gases such as argon, krypton, and xenon.

High-Z Doping of Glass Shells

A new process for making High-Z doped glass shells is based on the Si-GDP-to-glass conversion method (Hoppe process) and allows for the manufacturing of large, thick and exceedingly uniform shells. Germanium (Ge) doped glass shells are made essentially by the same process as pure silica glass shells except a Ge dopant is added during the GDP coating step.

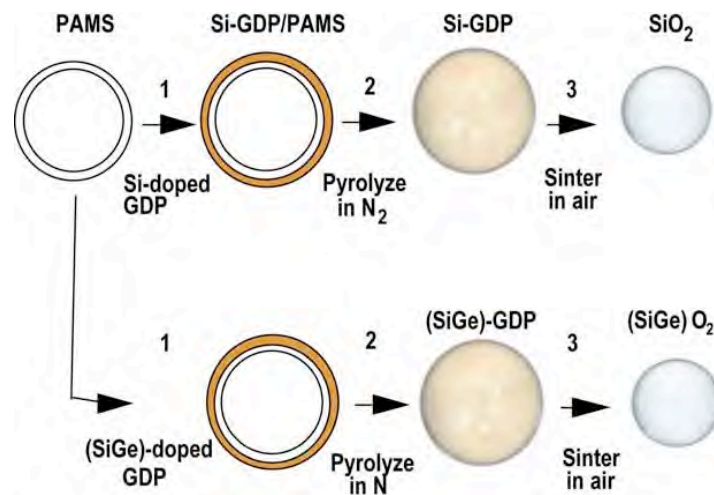

Ge-doped glass is made using the Si-GDP-to-glass process.

Beryllium Shells

GA can make beryllium shells over a range of outer diameters from a 440 μm diameter Nova-type capsule to 2000 μm diameter NIF-type capsule. Wall thickness can vary from less than 5 μm to over 160 μm . Surface finish depends on the wall thickness. For a 5 μm beryllium shell, the typical surface roughness is less than 50 nm RMS. For a thicker layer, mechanical polishing is available to reduce the surface roughness to very low levels. Beryllium shells can include dopants such as Cu. Profiled doping has been demonstrated.

Beryllium shells are fabricated by magnetron sputtering of beryllium targets under vacuum of $\sim 1 \times 10^{-6}$ Torr. GDP shells produced by plasma CVD are used as substrates. GDP shells are placed in a rolling pan and agitated. Columnar structure is commonly observed in the beryllium films. Beryllium coatings characterized by TEM show low void density and small void sizes. The typical density of the Be coatings is $\sim 94\%$ of the bulk density under normal sputtering conditions.

Thick beryllium shells produced by magnetron sputtering go through mechanical polishing to meet NIF specifications for surface smoothness. Polished beryllium shells show surface roughness <10 nm RMS. Copper-doped beryllium shells are produced by co-sputtering beryllium and copper. An additional target in our vacuum chamber is copper. By adjusting the copper target to substrate distance and sputtering power, different levels of copper and graded copper-doped beryllium shells are produced.



GA coater used for beryllium shell fabrication.

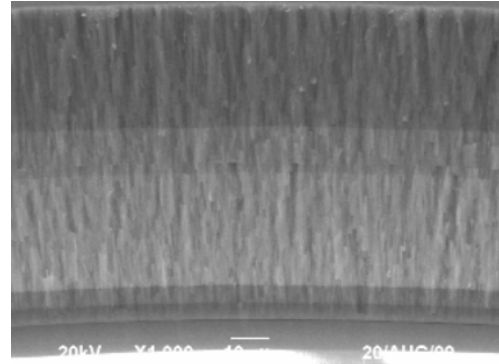

Cross section of a beryllium shell.



As grown After polishing
Beryllium shells.

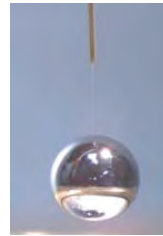

NIF beryllium capsule fill tube assembly showing a 2 mm shell with a 10 µm fill tube.

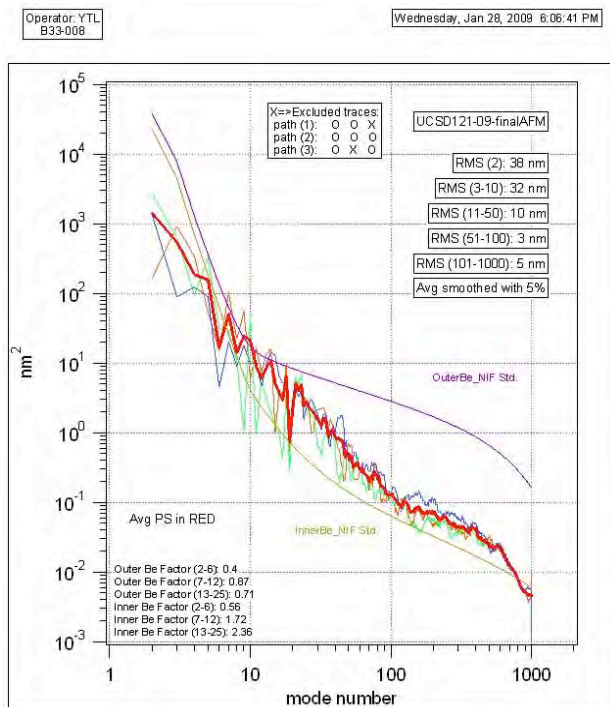

Polished beryllium shell surface power spectra.

Foam Shells

Some of the high gain direct-drive ICF designs involve a foam shell with a conformal permeation barrier seal coat. We can produce resorcinol formaldehyde (RF) foam shells in the range of 50 to 200 mg/cc, approaching 5 mm in diameter with wall thicknesses of 50 to 200 μm . These shells are produced in large batches, approximately several thousand. The shells are observed to have good wall uniformity. Foam shells are typically coated using the GDP coating process. Coated shells are gas retentive and can be filled with deuterium for laser shots. RF foam shells can be produced with small pores, less than 100 nm cell size which make the shells transparent. They can also be produced with large pores, greater than 100 nm cell size, at the expense of enhancing cryofilling.

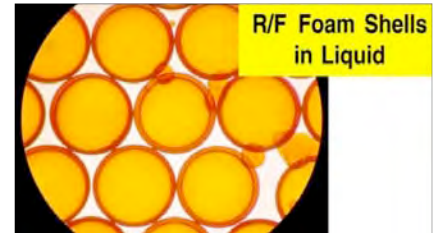

As-fabricated batch of 1 mm RF shells.

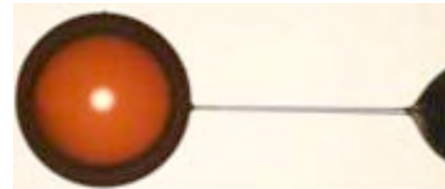

1 mm high density RF foam fill tube capsule.

Gradient Tungsten- Chromium (W/Cr) Metal Capsule

Upper left: SEM cross section of W/Cr gradient layer with insert of optical picture of a coated sphere.
 Upper right: W/Cr gradient from 100% W left to 100% Cr measured by EDS.

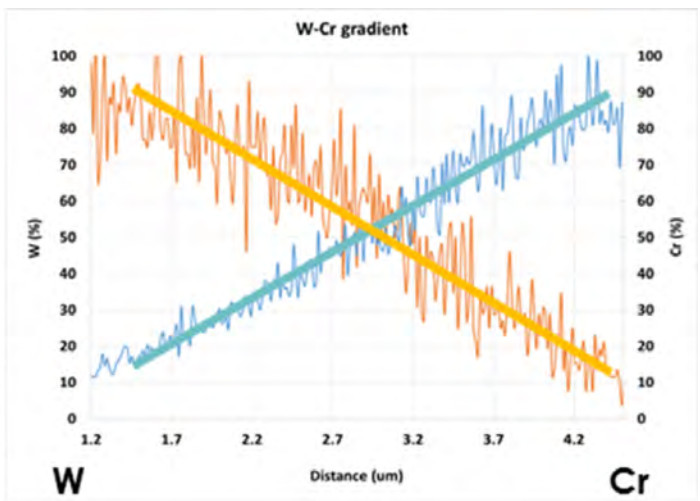
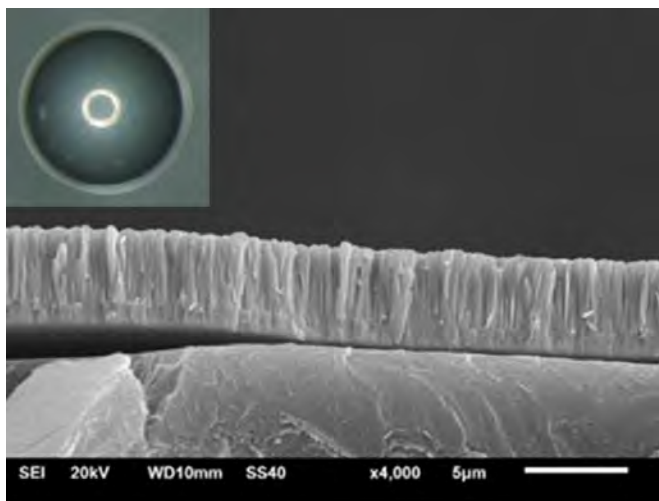

SPECIALTY SHELLS AND TARGETS

Fast Ignition Capsules. Fast ignition targets are a class of targets that our team produces. Gas retentive cone-mounted polymer shells can be routinely manufactured. These shells involve both our capsule fabrication and micromachining capabilities. Capsules ~1 mm in diameter are machined to produce a hole to accept the re-entrant cone. The glue joint between the shell and the cone is kept to a minimum. This provides a strong permeation seal and allows gas fills up to 15 atm inside the shell.

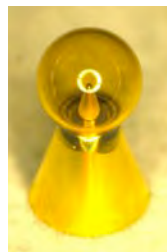

Double Shell Targets. Stalk-mounted double shell targets have been manufactured for HEDP experiments. The inner shell may be glass or polymer. The outer shell is typically a polymer shell machined to allow mounting of the inner shell. A gas permeation barrier can be placed on the outer shell to allow gas filling of the void between the two shells.

Hemi Shells. Another class of capsule targets that combines micromachining and capsule fabrication are hemispherical shells. The hemis are produced by making a batch of intact shells and then machining half of the shell away. This technique offers the advantage of mass fabrication of hemi shells with a relatively brief micromachining step which can also be done on several shells at once.



Machined hemi shell.

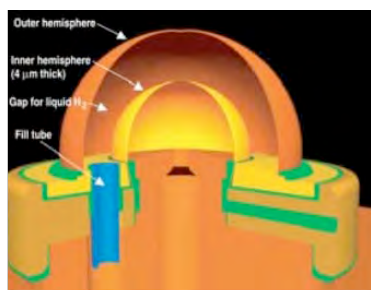

Cryo target design with two hemis.



Assembled cryo target with double hemi shell.

Gas Fills and Half-Life Measurements

Frequently, capsules require gas fills. We accomplish this task via elevated temperature permeation in three custom engineered systems designed and built at GA. The primary system automatically operates three separate fill lines and controls fill pressure from 0 to 10,000 psi using various preprogrammed fill profiles depending on capsule dimensions, material, and required fill pressure. The other two systems allow for sub-atmospheric gas fills completed using manual operation in both heated and room temperature modes. The gases that can be filled to capsules are limited only by the permeability of the gas for the capsule materials combined with toxicity or corrosive properties of the gas. Examples of filled gasses are shown in the table below.

Gas	Pressure Range	Comments
Deuterium/hydrogen	Up to 200 atm	Standard lab request
Xe, Ar, Ne	0.05 up to several atompsheres	“Standard” diagnostic gases
Deuterated methane	0.05 up to several atompsheres	“Special” diagnostic gases
SF6		

Once filled, we characterize not only the final fill pressure in the targets but also confirm the half-lives of the capsules to ensure that the target has the desired pressure needed at shot time. We established many techniques to accomplish these tasks utilizing various systems at GA. The technique utilized depends on a number of factors including the atomic number of the fill gas, expected half-life, quantity of gas and the material of the target. Primary methods include non-destructive techniques such as x-ray fluorescence, mass spectrometry, white light interferometry, and mass loss over time measuring the rate of out-gassing. Secondary methods include destructive techniques employing statistical sampling. One process uses a system with a known volume combined with a precision pressure gauge within which a capsule is burst. Another process is a technique that measures the size of a resultant gas bubble when a target is punctured under glycerin.



Production gas fill station.

Nonpolymeric Coatings on Shells

Our team has extensive metal coating capabilities as described in the coating section. We extended these techniques to coating ICF capsules.

The PVD systems available are routinely used to coat shells with various metals, such as:

Au, Al, Bi, Pd, W, Cu

and non-polymeric insulators such as:

SiO₂, B

Most coatings are performed on freely “bouncing” shells in a mechanically agitated holder. An electromagnetic shaker mechanism provides the proper agitation for the shells. Coatings on stalk-mounted shells can also be carried out.



SEM of tungsten coating cross section.



Tungsten-Coated Glass Shells

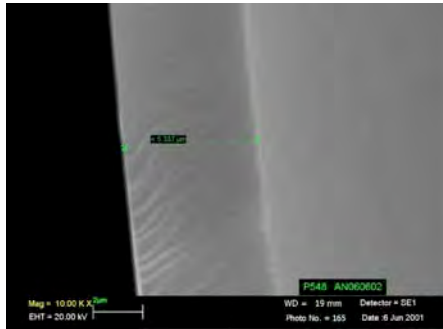

4. COATINGS FOR SPECIALIZED ICF TARGETS AND COMPONENTS

COATING CAPABILITIES

GA provides a variety of coatings for special applications.

Capabilities for coatings on substrates of various shapes uniformly: flat, cylindrical, and spherical substrates using appropriate agitation mechanisms as needed.

Plasma-enhanced chemical vapor deposition (PECVD) of pure and doped CH materials:

- CH, Ge-CH, Ti-CH, Si-CH, CD, Cu-CD, ... PVD of various metals and insulators:
- Au, Al, Bi, Pd, W, Cu, Nd, Dy, Pb, ...
- SiO₂, B, ...

The ability to sputter alloys of two or three metals.

Atomic Layer Deposition (ALD) of various metals and insulators.

Electroplating of various metals (Au, Cu, Ag).

Parylene coating capability needed for certain ICF experiments.

Chemical vapor deposition of polyimide thin films.



Line of sputter coaters.

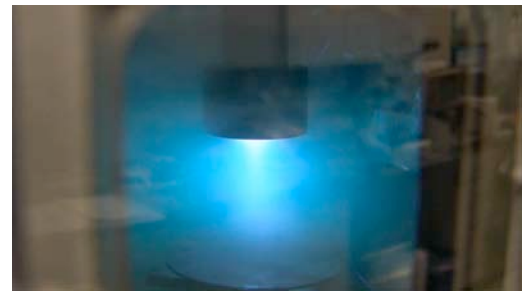

Sputter Coating of iron.



EQUIPMENT

We have 10 PECVD coating systems capable of continuous operation.

We have seven multi-gun sputter coating systems capable of running in dc and rf, and biased modes for PVD purposes. Three of which are dedicated to coating uranium. Each system is outfitted with ion sources for in-situ Ar ion cleaning.

Electron beam evaporation capability.

ALD coating system.

Several electroplating baths.

Parylene coater.

Polyimide coating system.

MULTI-LAYER “COCKTAIL” COATINGS

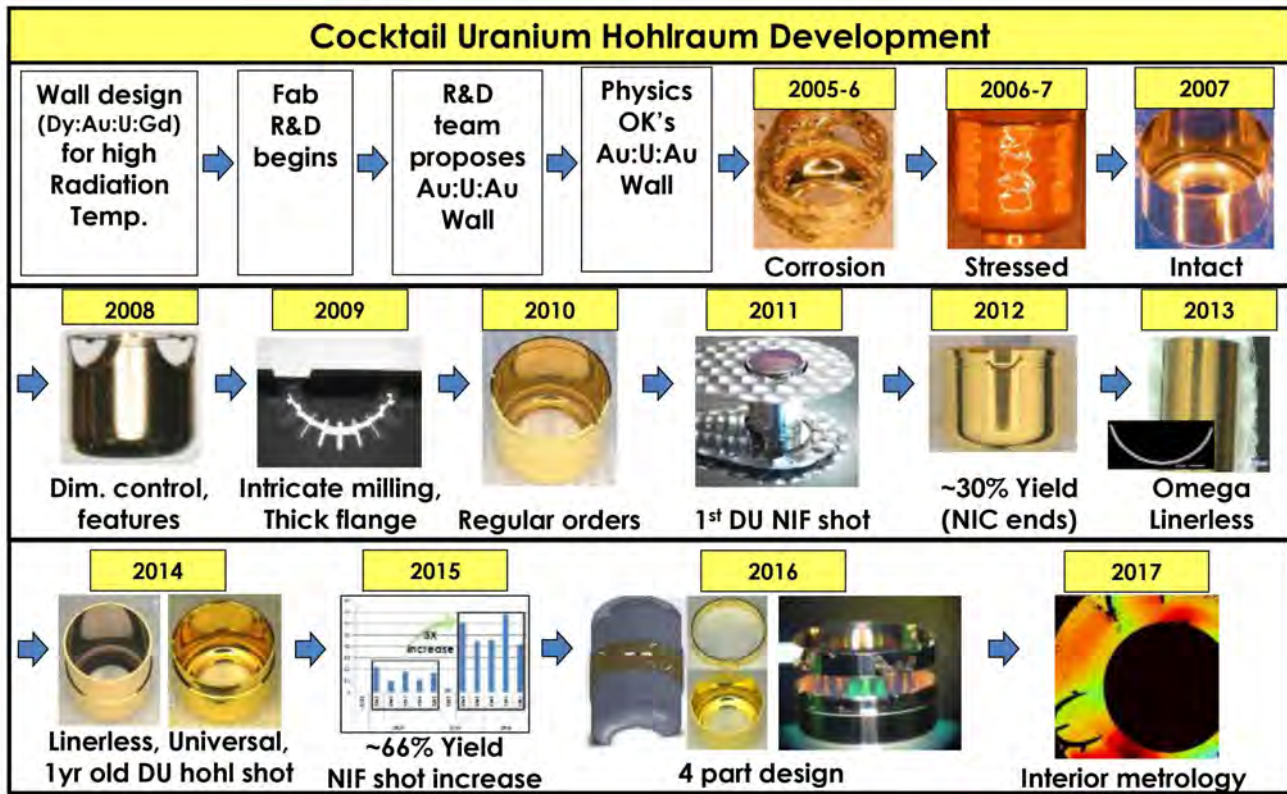

Coatings are made onto aluminum/copper mandrels that are machined to the required cylindrical dimensions. A 100 nm protective inner layer of gold is deposited first, and then the mandrel can be indexed back and forth between the DU and Au sputter sources to create multi-layers. For uranium hohlraums, several microns of gold are sputtered onto the starting mandrel prior to uranium coating to protect it from oxidation. After the uranium coating layer is deposited, the outer surface of the hohlraum is electroplated with a thin Au layer again to prevent oxidation of the uranium.

A Levin precision lathe, dedicated to machining parts coated with depleted uranium, is used to back-machine away the coating from the mandrel. The mandrel is then leached away, leaving a freestanding cylinder.

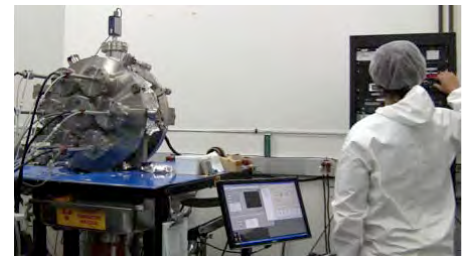

“Cocktail” coater.

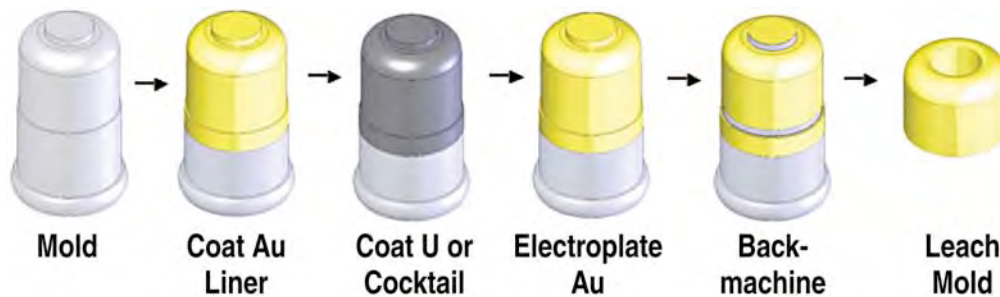

Fabrication steps for cocktail hohlraums.

GA-BUILT GLOW DISCHARGE POLYMER (GDP) COATING SYSTEMS

Specifications:

- Coating composition: CH, CD, Ge-CH, Ti-CH, Si-CH, ...
- Coating rate: <math>< 0.3 \mu\text{m/h} - 2 \mu\text{m/h}</math>
- Surface finish: Typical $R_q \sim 10\text{-}100 \text{ nm RMS}$
 R_q as low as $\sim 1 \text{ nm RMS}$ (rate dependent)
- Coating area: $\geq 2 \text{ cm diam}$
- Foot print: 32 x 84 in.
- 110VAC or 220VAC operation



System Includes:

- RF plasma unit and power supply.
- Coating chamber (~5 in. diam).
- Gas and pressure control units.
- Agitation system (for non-flat targets).
- Timer for extended operation.

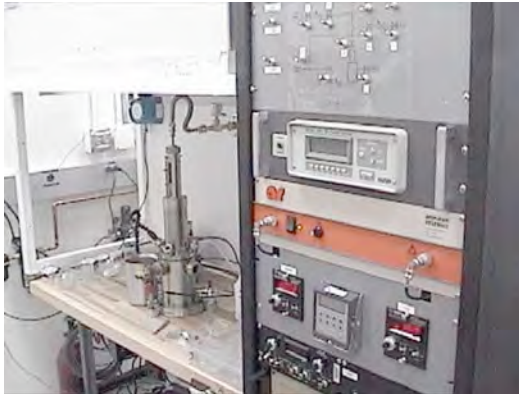

Description:

The GDP coating systems built at GA have been used for ICF target fabrication for nearly 20 years. Currently, there are ten GDP coating systems at GA which are operated virtually 24 hours a day, 7 days a week. These GDP coaters are highly reliable as evidenced by their nearly continuous operation. They have a long track record in producing nearly all of the spherical targets for ICF experiments at a variety of laser and pulsed power facilities in the U.S., including OMEGA, Z, and NIF. GDP, which in its simplest form is pure hydrocarbon, is currently the main ablator material for ICF capsules. Roughness of GDP coatings can be made below 10 nm RMS for coatings as thick as 100 μm .

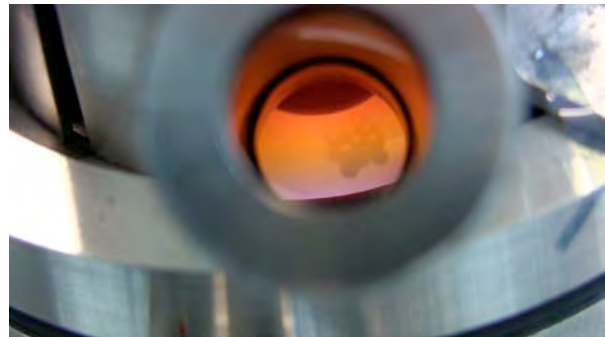

We fabricated undoped GDP coatings with the depolymerizable mandrel technique, also exotic multilayer targets have been made for a variety of important spherical ICF experiments. GDP is one of the candidates for NIF ignition capsule material. In addition, cone-mounted doped and undoped GDP shells have been used for fast ignition targets.

The French ICF program acquired a GDP coater from GA in 2000. Their system was built and commissioned at Valduc on schedule. The GDP coater at CEA has been functioning trouble-free and provided the means of fabricating spherical targets with the desired surface finish. We provided technical support for 6 months subsequent to installation of this GDP coater.

The GDP coater dimensions are approximately 32 in. wide and 84 in. long. The coater includes the coating chamber, plasma head, an instrument rack with gas controllers, plasma power supplies, shell agitation power supplies and a control panel. Vacuum pumps are supplied. Plumbing for the vacuum line and gas lines as well as gas bottles and regulators need to be supplied by the user. The electrical requirements include 5 outlets at 110 to 120 VAC, 20A. In addition, proper electrical supply is needed for the pumps. The coater can be configured for 220 VAC if desired. Power transformers may be needed in that case, which will be supplied with the coater. GA can provide consulting for 6 months after commissioning. All the coater-related instruments have their manufacturers' original guarantee.

Atomic Layer Deposition Coatings

GA IFT has an Atomic Layer Deposition (ALD) coating system. The ALD coating system allows angstrom (0.1 nm) thickness control since each coating cycle grows a single atomic layer. Metal, oxide, and nitride pinhole-free coatings can be fabricated using ALD. ALD is similar in chemistry to chemical vapor deposition (CVD), except that the ALD reaction breaks the CVD reaction into two half-reactions, keeping the precursor materials separate. Due to the characteristics of self-limiting and surface reactions, ALD film growth makes atomic scale deposition control possible.

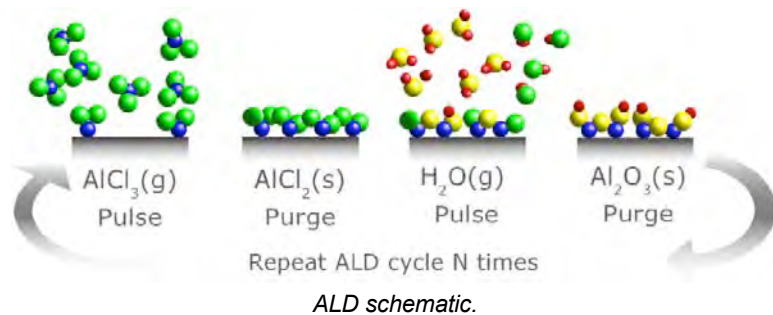

ALD system.



ALD coated plate.

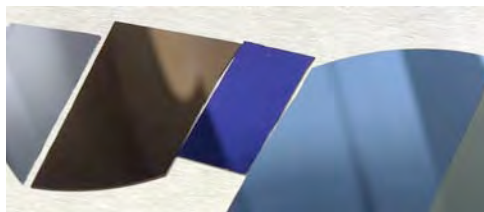

Various ALD pinhole-free coated samples.



5. CHEMISTRY AND FOAM FABRICATION

GA produces a variety of foams used as stand-alone capsules, targets to prevent diagnostic hole closure, and to support diagnostics or delicate capsules. Foams currently available are listed below.

Foam	Density Range	Cell Size	Dopants	Chemical Composition	Production Issues
HIPE polystyrene	15–700 mg/cm ³	1–10 μm	Halogens deuterated Physical dispersions	CH	Molded or machined to shape Vacuum dried
Resorcinol-formaldehyde aerogel	20–850 mg/cm ³	nm	Chemical modification Physical dispersions	62 wt% C, 38 wt% O&H Carbonized 93 wt% C	Molded to shape Supercritical drying Carbonized is machined
Silica aerogel	10–700 mg/cm ³	nm	Chemical modification Physical dispersions	SiO ₂	Molded or machined to shape Supercritical drying
Divinyl benzene	15–200 mg/cm ³	1–4 μm	Deuterated	CH	Molded to shape Supercritical drying
TPX (poly 4-methyl-1-pentene)	3–250 mg/cm ³	1–15 μm	Physical dispersions Embedded objects	CH ₂	Molded or machined (higher densities)

All of the foams are produced from a solution. It is the capillary forces placed on the foam during the removal of the solvent that determines the lowest possible density. To minimize the capillary forces, the foams are dried by vacuuming, freezing, or supercritical CO₂.

To characterize, we have specialized equipment designed for the very low-density foams, including radiography, confocal, and interference microscopy. We have three radiography systems to cover the energy range from 10 to 150 kV.

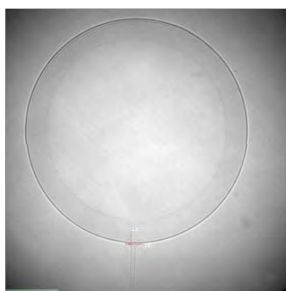

Radiograph of 1 mm foam capsule with fill tube.

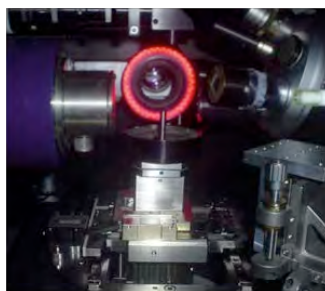

Xradia detector chamber.

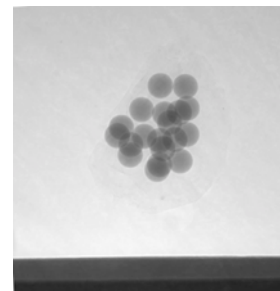

Xradia image of foam target with suspended sphere clump.

Foam	Density Range	Cell Size	Dopants	Chemical Composition	Production Issues
HIPE polystyrene	15–700 mg/cm ³	1–10 μm	Halogens deuterated Physical dispersions	CH	Molded or machined to shape Vacuum dried

Polystyrene emulsion polymerization foam was developed jointly by LLNL and Los Alamos National Laboratory (LANL). It is produced by combining a water phase and an oil phase into an emulsion stabilized with a surfactant. The oil phase can be quite small — 10% or less of the volume. The water phase contains the radical initiator; the oil phase contains monomer, surfactant, and solvent to dilute. The emulsion is formed using a pneumatic syringe pump and exchanging the solution between two syringes. The monomer is then polymerized, the surfactant washed out and the foam is dried. For larger volumes of foam, a high viscosity stirrer can be used. The advantages of polystyrene foam include its strong modulus and ease of doping. Its limitations include its larger cell size and the requirement that each piece may need to be individually machined.

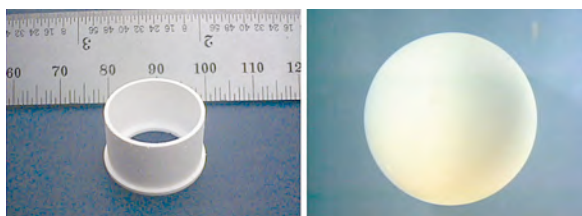

Examples of machined polystyrene foam components. The sphere on the right is 5 mm in diameter.

RESORCINOL FORMALDEHYDE (RF) AEROGEL

Foam	Density Range	Cell Size	Dopants	Chemical Composition	Production Issues
Resorcinol-formaldehyde aerogel	20 – 850 mg/cm ³	nm	Chemical modification Physical dispersions	62 wt% C, 38 wt% O & H Carbonized 93 wt% C	Molded to shape Supercritical drying Carbonized is machined

RF foam is produced by reacting resorcinol and formaldehyde. It is an aerogel, with nanometer scale cell size. It can be molded to shape and used as RF, or it can be heated to 1000°C in an inert atmosphere where it becomes an almost pure carbon aerogel. Carbonized resorcinol formaldehyde (CRF) can be machined to shape.

RF advantages are very small cell size and a well understood gelling mechanism (this allows micro-encapsulation to produce shells). The limitations are (1) the density cannot be less than 20 mg/cc, (2) it contains oxygen, and (3) super critical drying is required (a time-consuming step).

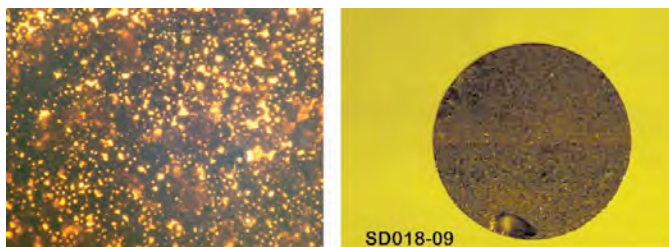

Examples of RF and CRF foam. The foam on the left is an RF foam in which 70 μm diameter polystyrene beads have been distributed throughout. This foam was designed for an EOS experiment and was to model the density distribution found in heterogeneous nebulae in space. The foam on the right is a machined CRF disk. Note the chip at the bottom. CRF foam is very brittle.

SILICA AEROGEL

Foam	Density Range	Cell Size	Dopants	Chemical Composition	Production Issues
Silica aerogel	10 – 700 mg/cm ³	nm	Chemical modification Physical dispersions	SiO ₂	Molded or machined to shape Supercritical drying

Silica aerogel was the first aerogel produced and has many unique characteristics. It has the nanometer cell size of an aerogel (transparent) and is almost colorless. It can be machined or molded to shape. We have produced disks of silica aerogel and have coated the disks with metallic coatings. The advantages of silica aerogel are very small cell size and optical properties. The limitations are high atomic weight atoms (silica and oxygen) and the time and equipment requirements of supercritical drying.

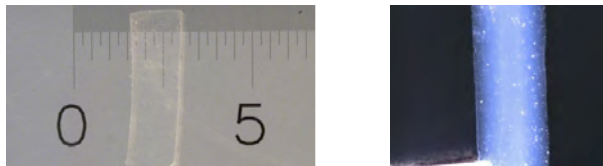

Typical silica aerogel sample used in assemblies having low density foams.

Foam	Density Range	Cell Size	Dopants	Chemical Composition	Production Issues
Divinyl benzene	10 – 200 mg/cm ³	1 – 4 μm	Deuterated	CH	Molded to shape Supercritical drying

Divinyl Benzene (DVB) is a pure carbon and hydrogen foam system capable of production at densities down to 10 mg/cm³. It has been molded into cylinders and microencapsulated to produce spheres. It can be produced in a deuterated form. The advantages of DVB are that of pure carbon and hydrogen and low density. The disadvantages are difficult to cast and it cannot be machined. DVB capsules are a reference target design for Inertial Fusion Energy.

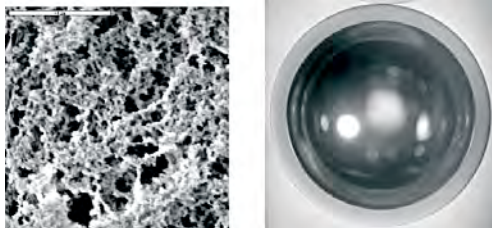





The SEM shows the foam structure of a DVB foam. The capsule on the right has a 4 mm diameter with a 300 μm wall. It is a prototype for the IFE target design.

TPX

Foam	Density Range	Cell Size	Dopants	Chemical Composition	Production Issues
TPX (Poly 4- methyl-1- pentene)	3–750 mg/cm ³	0.3–15 μm	Physical dispersions Embedded objects	CH ₂	Molded or machined (higher densities)

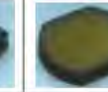
Poly 4-methyl-1-pentene (TPX) foam has been used for a long time in high-energy experiments and is the current foam of choice at Sandia National Laboratory (SNL) for its Z-pinch experiments. The foam is produced by dissolving the polymer in a heated solvent. The solution is then cast and cooled. The solvent is removed by freeze drying. Casting is less labor intensive than machining and permits precision placement of embedded objects. We also have doped TPX with elements such as molybdenum, gold, platinum, silica, titanium, and chlorine. When using nanoparticles, the foam can be doped to as much as 50% by weight. The advantages of TPX include ease of manufacture, pure hydrocarbon, low average z and low densities. The disadvantages are very soft modulus and large cell size. Recently, however, we reduced the cell size by the addition of polyethylene and dendrimer polymers.

DOPED PLASTICS

21 44.955910 Sc ² D _{3/2} 1.36 Scandium	22 47.867 Ti ³ F ₂ 1.54 Titanium	23 50.9415 V ⁴ F _{3/2} 1.63 Vanadium	24 51.9961 Cr ⁷ S ₁ 1.66 Chromium	25 54.938049 Mn ⁶ S _{3/2} 1.55 Manganese	26 55.845 Fe ⁵ D ₄ 1.83 Iron	27 58.933200 Co ⁴ F _{9/2} 1.88 Cobalt	28 58.6934 Ni ³ F ₄ 1.91 Nickel	29 63.546 Cu ² S _{1/2} 1.90 Copper	30 65.409 Zn ¹ S ₀ 1.65 Zinc	32 72.64 Ge ³ P ₀ 2.01 Germanium
										

Synthesized metal doped plastics for warm dense matter spectroscopy. Transition metals produce spectra interrogated by new spectrometers.

COMPOSITE PLASTIC/FOAM PLANAR TARGETS

GA IFT possesses traditional planar film manufacturing capabilities including casting or spin-coating, as well as precision hot pressing with sub-micron-level control. GA IFT has improved the quality of a class of planar targets, which require exacting dimensions for efficient, precision plug-and-play assembly, using its extensive precision milling and laser machining capabilities; for example in making small features or sinusoidal perturbation on planar foams, including doped foams, which are otherwise impossible to make without damaging the target.

GA produces a variety of planar targets and films for ICF and HEDP research. Uses for planar targets include imprint studies, instability growth and quenching studies, equation-of-state measurements, driver calibration, target back lighters, and feed out studies. The targets usually have a polymer film component and often have machined or vapor-deposited metallic layers. GA planar targets are individually crafted to precise customer requirements and characterized to meet a complete set of specifications.

We produced multilayer flats with perturbations where one of the layers is a low density foam. An example of a composite plastic/foam target with a rippled surface for tracking shocks in EOS experiments is provided below along with other novel surface modulated targets.

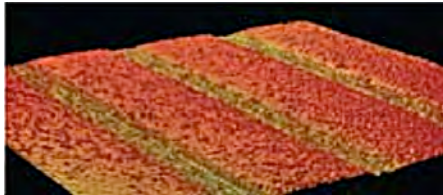

Machined features of a rippled composite CH/foam target.

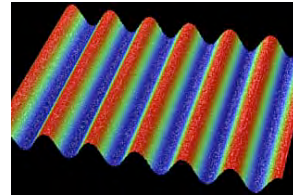

Machined CH plastic with 50 μm λ, PV 1.0 mm.

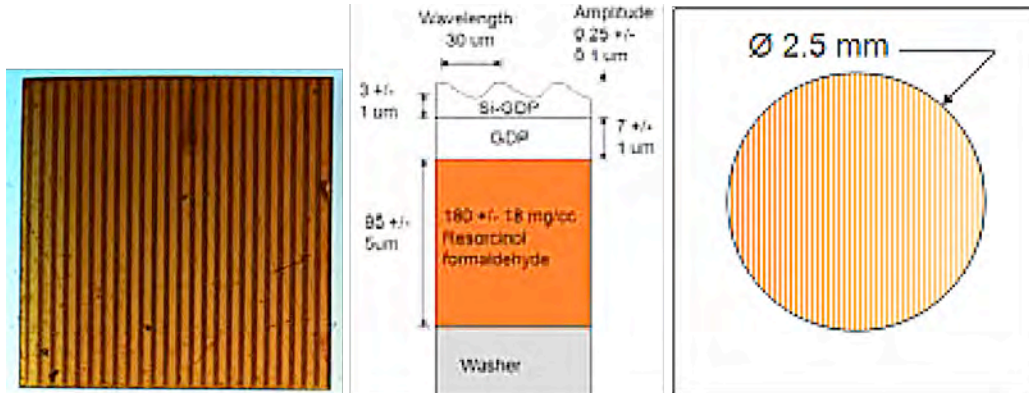

Si-doped and un-doped multi-layer system: GDP/CH/RF/washer λ = 30, 60, 120 μm.

Material	Thickness	Tolerance	Surface (μm PV)
Polystyrene	5 – 100 μm	0.1 μm	5
Polyimide	150 nm – 50 μm	10% or 0.1 μm	5

We manufacture high-quality smooth polymers to use as components in planar targets. The most commonly used polymers are polystyrene and polyimide. Our specialty is casting polystyrene and polyimide into defect-free films with better than 5 nm RMS roughness. Polystyrene films range from 5 μm to over 100 μm in thickness while polyimide films are normally less than 15 μm in thickness down to 150 nm.

Most ICF/HEDP targets require pure polymers as components. If needed, we provide polymers with controlled impurities to change emission characteristics or density. We have routinely provided chlorine-doped polystyrene and silicon-doped polystyrene and can deliver films with other dopants as well. Typical concentrations of dopants are between 2 and 6 at. %.

MICROWIRE BACKLIGHTERS

General Atomics developed a lithographic process to produce microwire targets as small as 5–10 μm in height and width on low-Z substrates (Al, CH). The microwires produced include the metals Au, Ag, Cu, Dy, and may be extended to other metals. The microwires are used as backlighters in ICF experiments. Various fabricated microwire examples are presented below.



Fabrication of microwire backlighters.

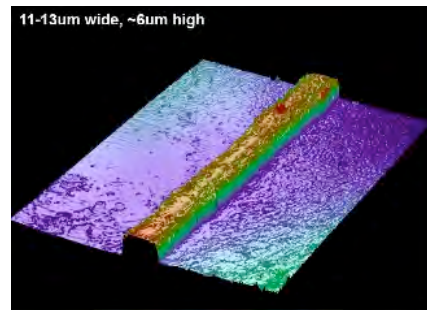

WYKO image of Au microwire backlighter.

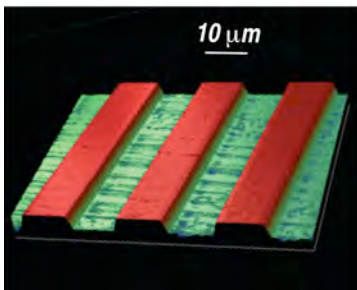

WYKO image of microwire preforms.

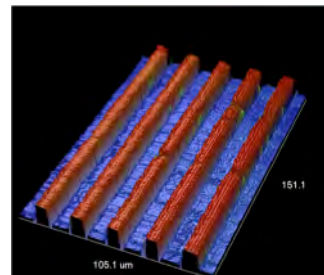

WYKO image of set of fabricated Cu microwires.

6. LASER MACHINING

LASER MACHINING CAPABILITIES

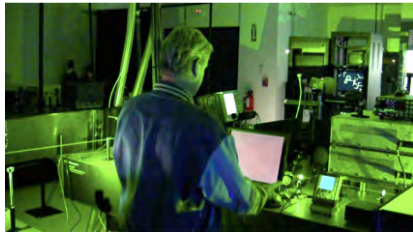
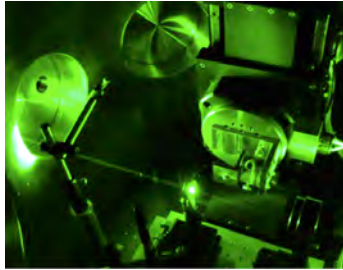

General Atomics developed unique laser machining capabilities through its world-leading laser expertise, substantial internal investment, and by supporting ICF target fabrication. The laser applications laboratory has several nanosecond lasers, a femtosecond laser, a vacuum-compatible CNC micron-resolution motion control system, optical and electronic diagnostic equipment for laser-matter interaction studies, and process development, as well as an excimer-laser machining station. More importantly, what distinguishes the GA IFT laser applications laboratory from other laser machining labs is its vast experience and in-depth expertise in the area of theoretical and experimental laser matter interactions and plasma physics related to laser processing of materials. In addition, there is integration of such expertise at GA with other key capabilities of metallurgy, metrology, and diagnostics. Below are examples of unique, laser-machined materials produced by GA's Inertial Fusion Technologies laser applications lab.

The GA IFT laser machining lab's production effort is categorized in three primary areas: Diagnostic arrays, backlighters and attenuators in support of NIF/OMEGA ignition experiments, beryllium and CH capsule hole drilling as part of the NIF target fabrication production process, and fabrication of various target components in support of ICF experiments on the OMEGA and Z facilities at LLE and SNL respectively.

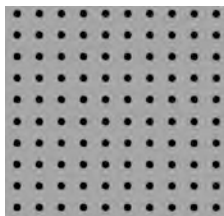

Dante sieve used in NIF diagnostics. Sample of array of 6000 precisely spaced holes in tantalum, laser machined using nanosecond lasers.

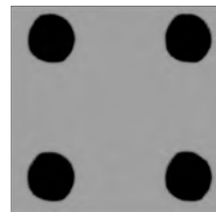

Enlargement of Dante sieve holes. Holes are 50 μm in diameter showing excellent edge quality.

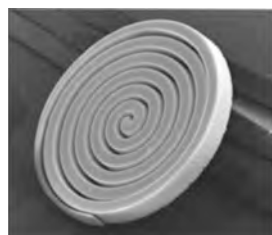

Free-standing spiral machined from tantalum oxide aerogel using 248 nm excimer laser. Diameter of spiral samples is 2 mm.

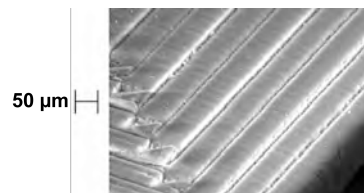
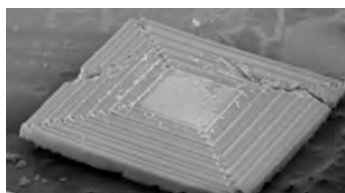

Machined aerogel pyramid showing example of high precision depth control achieved using laser machining.



Example of high aspect ratio laser-drilled counter bore hole in beryllium shell.

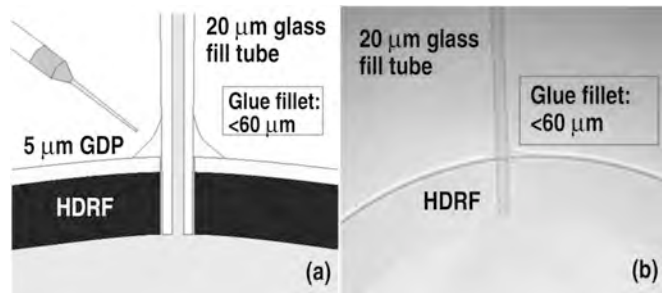

(a) Schematic of laser-drilled plastic capsule with fill tube.
 (b) Final capsule with fill tube after laser machining and assembly.

GA IFT has fabricated multiple Pinhole and Collimator sets and filters for several NIF diagnostics: GXD, hGXI, SXI filter packs, and Dante filters. We have implemented a contact radiography and OCMM process to characterize the components. Feature coordinates and shape information are evaluated in part by a least square fitting routine with respect to the positioning locations to ensure 100% pinhole to collimator alignment (see below).

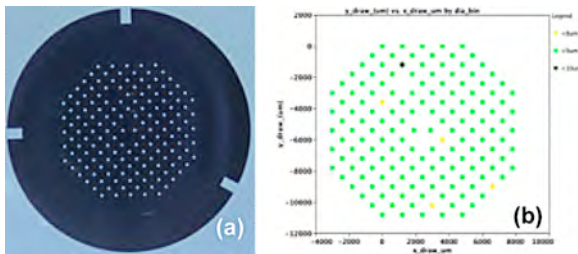

(a) 156 hole GXD Ta Collimator (b) Example Quality Control maps for hole size and positions.

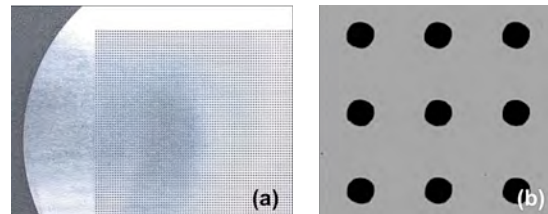

(a) Dante attenuator array, 6,400 holes 50 μm diameter through 25 μm thick Ta, (b) digitized close-up image of same.

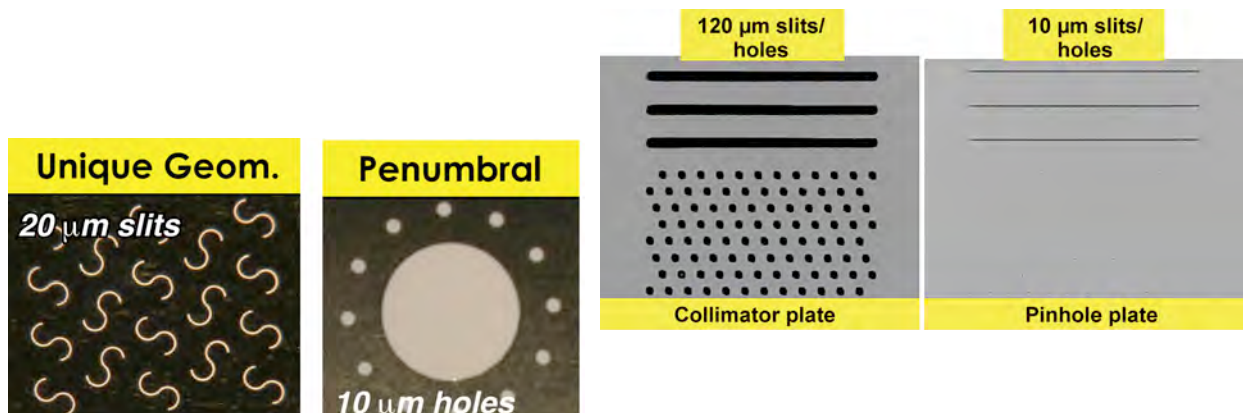

Additional examples of GA IFT laser micro-machined components.

7. NIF TARGETS, COMPONENTS, DIAGNOSTICS

General Atomics IFT fabricates and supplies the majority of the components that make up the NIF Ignition Target. The main components GA IFT provides are capsules and capsule fill tube assemblies (CFTA), hohlraums, diagnostic bands, cones, thermal mechanical packages (TMP), LEH inserts, and LEH window washers.

Below is shown an exploded and assembled view of the NIF ignition target. Also provided are examples of some of the GA IFT fabricated components.

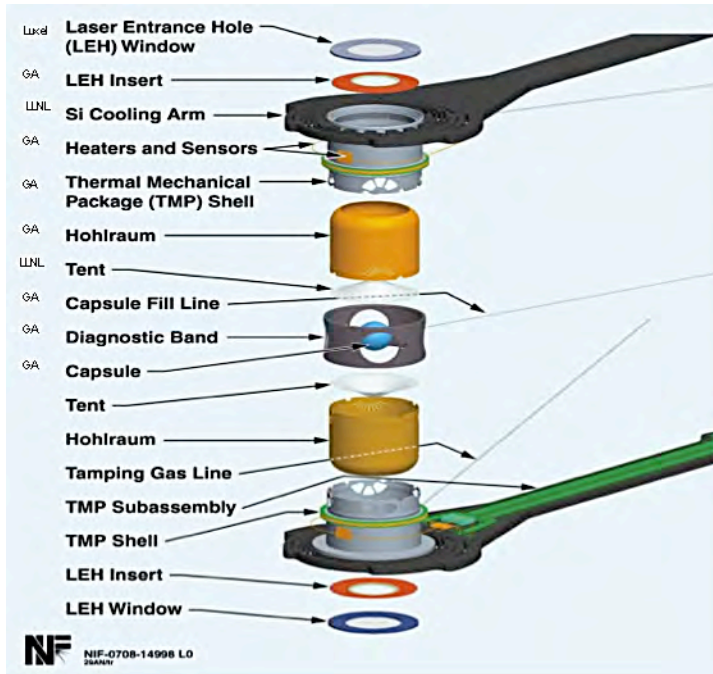

Exploded view of NIF ignition target.

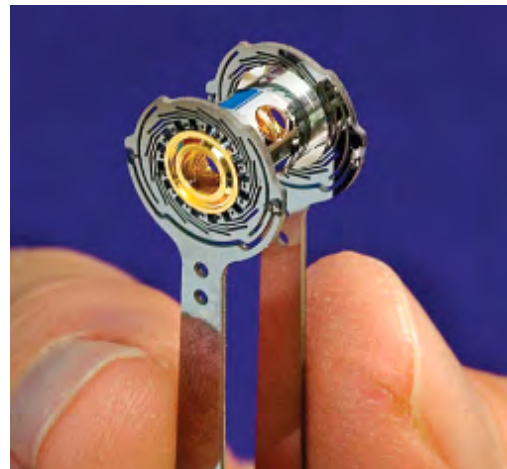

Final assembled NIF ignition target.



Diagnostic band.

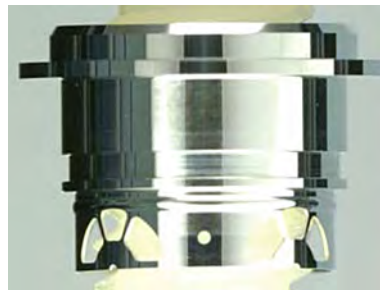

Aluminum can.

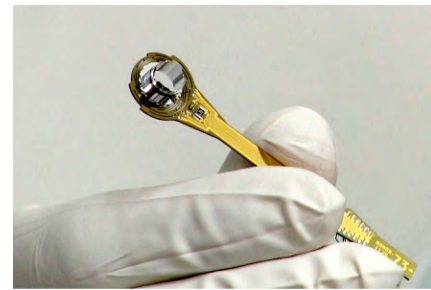

TMP subassembly.

NIF CAPSULES

The process for fabricating plastic NIF capsules starts with a micro-encapsulation process to produce a poly-alpha-methyl styrene (PAMS) mandrel. The PAMS mandrel gets coated with a crossed linked polymer called glow discharge polymer (GDP). The mandrel is then removed through pyrolysis. A 10 μm diameter hole is then laser-drilled through the capsule, into which a fill tube is attached with a uv-curing adhesive. Capsules are fully characterized using the following: phase shifting diffractive interferometry (PSDI), atomic force microscopy (AFM), contact radiography (CR), scanning electron microscopy (SEM), Xradia, energy dispersive x-rays (EDS), x-ray fluorescence (XRF), precision radiography and x-ray absorption spectroscopy. The capsule fabrication and characterization process is shown.

To the right are two examples of Capsule-Fill-Tube-Assemblies (CFTAs). On the left is a plastic shell CFTA, on the right is a Be shell CFTA.

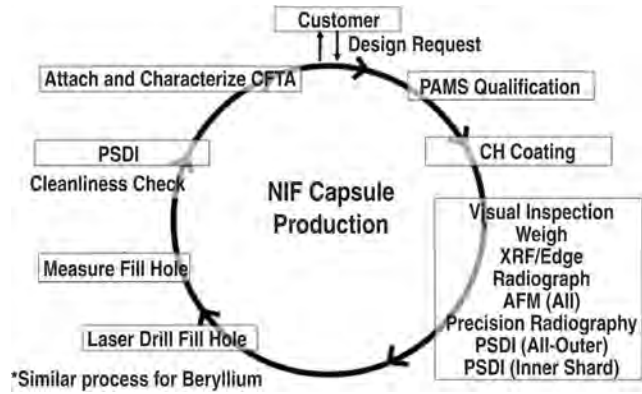

Flow chart for NIF capsule production.

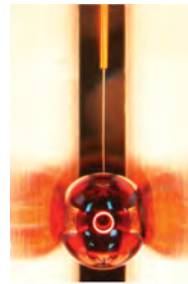

GDP Capsule



Be Capsule

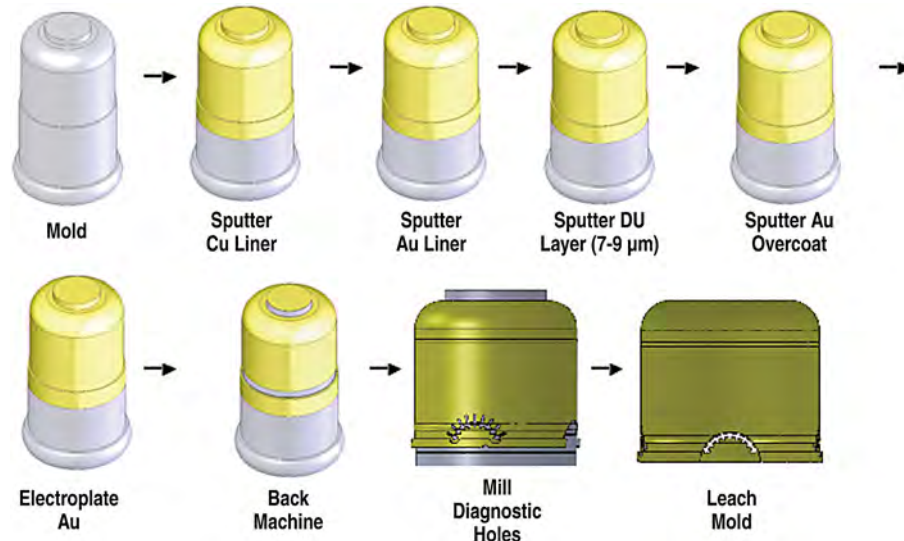

NIF HOHLRAUMS

The NIF hohlraum fabrication process is shown schematically in the image to the left. GA IFT has the ability to fabricate both uranium (cocktail) and Au hohlraums.

The evolution of the depleted uranium (DU) and gold (Au) hohlraums is depicted in the figure below.

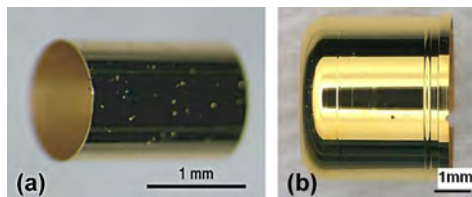

(a) 2005 OMEGA cocktail hohlraum.
(b) 2011 NIF cocktail hohlraum with machined features in flange and sidewall

8. METROLOGY AND CHARACTERIZATION DEVELOPMENT

GA's IFT production labs characterize their deliveries to whatever level the customer requires in geometry, composition, surface finish, material properties, and gas permeability. The following information lists current measurements and equipment. We are continuously developing new capabilities to meet customer needs.

GEOMETRY AND MATERIAL PROPERTIES

Our spheres, hohlraums, and machined plates must meet exacting standards to perform properly for the high energy density experiments in which they are used. We adapted and developed a unique set of measuring tools to verify their dimensions and topology.

Because our customers require doped layers in many of our shells which incorporate a wide variety of elements and are sensitive to the presence of other elements (i.e., oxygen), we developed a number of techniques for the microanalysis of our components.

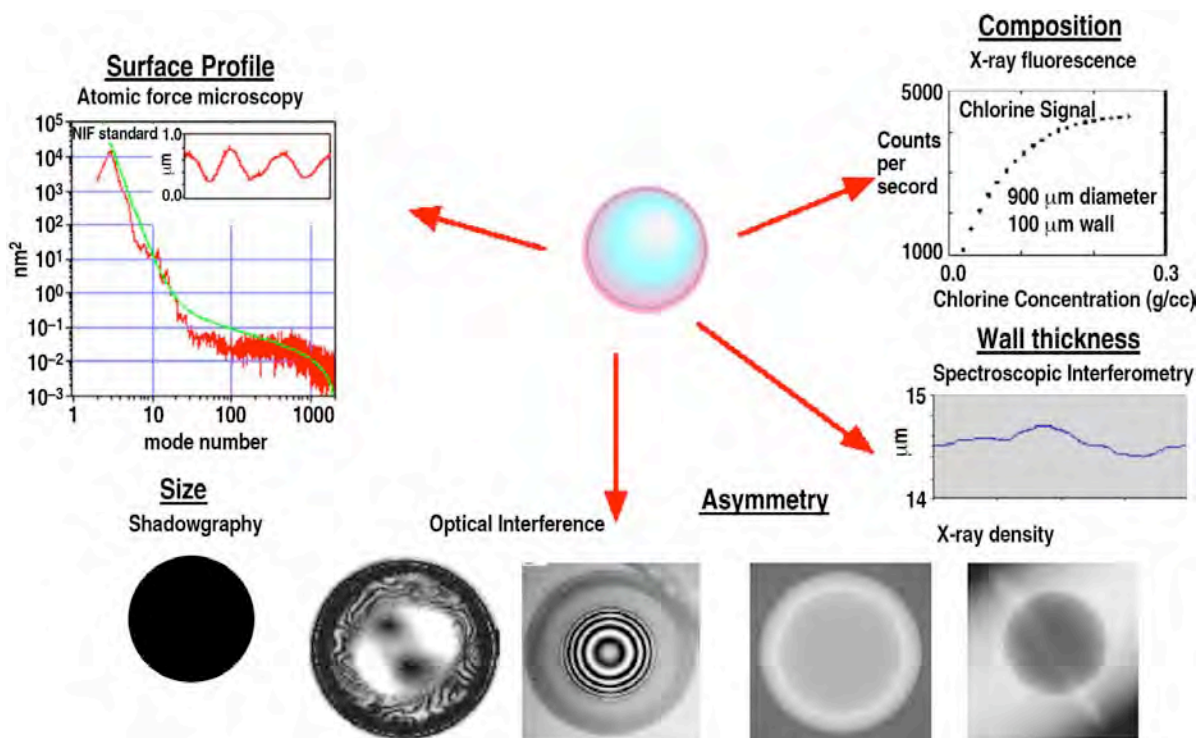

Examples of Techniques:

- Contact radiography (CR)
- Energy Dispersive Spectroscopy (EDS)
- X-ray Absorption Edge Spectroscopy (Edge)
- Precision Radiography (PR)
- X-ray Tomography Microscope (Xradia)
- Spheremapper (SM)
- Phase-Shifting Diffraction Interferometer (PSDI)
- Automated Microscope (AM)
- Acoustic Imaging Microscope (Sonoscan)
- Spectroscopic Ellipsometry

Technique Measures:

- Dimension, dopant
- Dopant, impurity
- Dopant, impurity
- Homogeneity
- Dimension, homogeneity
- Surface finish, sphericity
- Isolated defect, surface
- Dimension
- Dimension, defect
- Dimension

Contact Radiography

We developed a nondestructive technique to profile graded dopants in ICF shells to the precision required by NIF specifications, a key technology that enables the close-loop dopant quality control in target fabrication. This quantitative contact radiography method was based on precision film digitization and a dopant simulation model. Recently, we improved the technique to differentiate copper and argon profiles which can be simultaneously present in a shell wall. We can detect dopant variation to better than 0.1 at. %. The average dopant is accurate to ± 0.1 at. %. Contact radiography also provides accurate dimensional information through the proper corrections of various distortions induced by the imaging lens, the point projection geometry, and x-ray refraction. The procedures we developed allow measurement accuracies of ± 0.5 μm for the capsule diameter, ± 0.2 μm for the out-of-round [(OOR) which is the amplitude of the radius variations], ± 0.3 μm for the wall thickness (including each sublayer), and ± 0.1 μm for wall thickness profile.

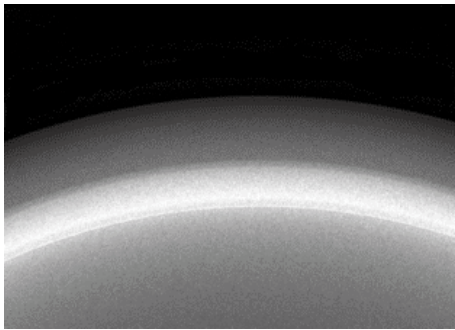

Contact radiography image of graded Be shell.

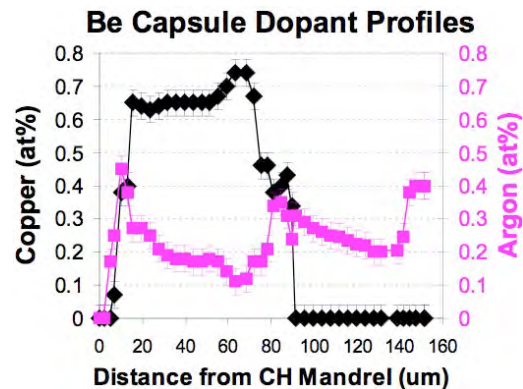

Energy Dispersive Spectroscopy (EDS)

The NIF point-design ablator capsule contains copper as the dopant and argon and oxygen as contaminants. The concentrations and profiles need to be measured to ± 0.1 at. % (copper), ± 0.1 at. % (argon), ± 0.4 at. % (oxygen), respectively. We developed a physics-based EDS model and fabricated standards to make it quantitative for low concentration of relatively light elements in a very low-Z matrix. No commercial EDS model exists that is applicable to beryllium with low concentration of dopants.

X-Ray Fluorescence (XRF)

Commercial XRF systems can only calculate elements atomic percent in flat samples. We developed a unique XRFer program for quantitative XRF computation on spherical samples such as the ICF ablator capsules. This method is accurate to 10% for high-Z elements and has the trace detection capability at 1 ppm level for contamination control.

White-Light Interferometer

We developed a custom white-light interferometer to measure the wall thickness of multilayered transparent shells to 0.05 μm accuracy. This method, though limited to measure the wall only at the North Pole and the South Pole, is the primary calibration standard used to benchmark other wall thickness characterization tools.

Spheremapper

Spheremapper uses AFM to measure equatorial traces on a rotating shell and is used to measure (high mode) surface roughness and (low mode) shell distortion on ICF shells to NIF specifications with 1 nm system noise. Until a few years ago, Spheremapper gave only a statistical picture of the capsule surface. The standard set of profiles (three parallel traces along three mutually orthogonal great circles) sampled only a small fraction of the surface of the capsule. We made a two part upgrade: (1) new motor drivers and software allowed the atomic force microscope (AFM) head to follow the curve of the capsule up to ± 0.3 radians from the equator, and (2) new analysis software allowed the reconstruction of these traces into a representation of the complete capsule surface. With these upgrades, Spheremapper is capable of providing complete and accurate measurements of the mid modes. We also constructed a second Spheremapper located in a NIF clean room laboratory to meet the production metrology throughput required for NIF shells.

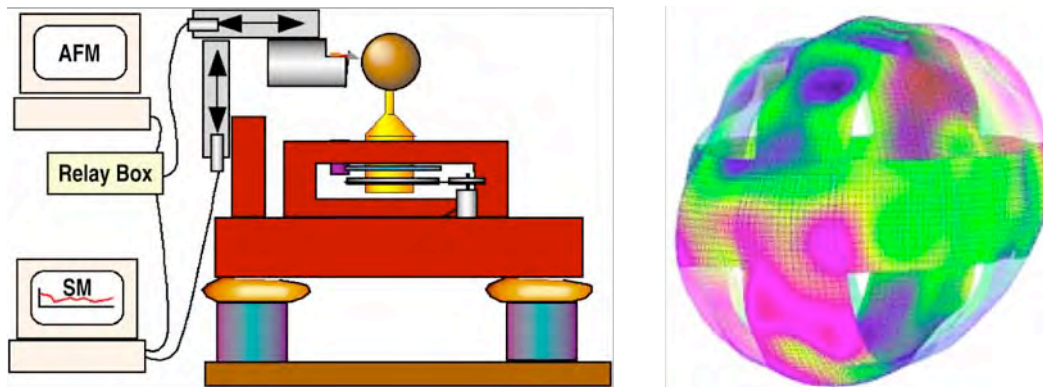

The setup of the AFM drives facilitate full surface mapping, an important improvement over previous characterization. The spheremapper controller can move the AFM head along the curve of the capsule ± 0.3 radians from the equator before interference between the AFM head and the capsule. To do this, the SM controller must take control of a motor normally used by the AFM system for automatically engaging the AFM tip. The distortions are magnified 300 times in the view.

Whole-Image White Light Interferometry (WYKO)

Using a WYKO, we can map and give quantitative statistics of transparent or machined surfaces with a maximum extent ~ 1 cm, minimum resolution laterally < 10 nm, and vertically < 10 nm.

Optical Microscopy

We have a large number of Nikon metrology microscopes whose objective and stage configuration can be modified to suit specific measurement needs.

Automated Microscopy

We developed batch measurement tools for screening PAMS and GDP shells for outer diameter, inner diameter, wall thickness, out-of-round, and non-concentricity. It is based on a Nikon NEXIV measuring microscope with custom programming. The batch tool enables 20 shells to be measured at a time without operator presence which greatly increases our production metrology throughput. It also complements the white-light interferometer and the wallmapper very well.

Wallmapper (Transparent Capsules)

In the original version, the wallmapper was a piggy-backed instrument on the Spheremapper. It uses a FilMetric spectrometer to measure the optical thickness of transparent samples based on the spectral interference. It uses the Spheremapper rotary encoder to keep track of the angles. The wall thickness trace obtained this way is repeatable to 1 nm precision. The accuracy is limited by the knowledge on the refractive index. Recently, we constructed a second, stand alone wallmapper to meet the increasing demand of NIF metrology.

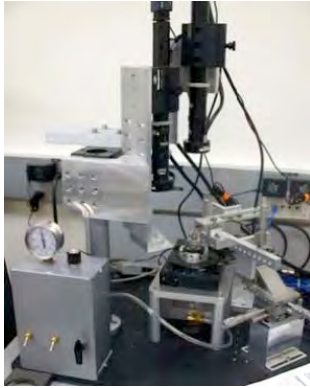

GA built Wallmapper.

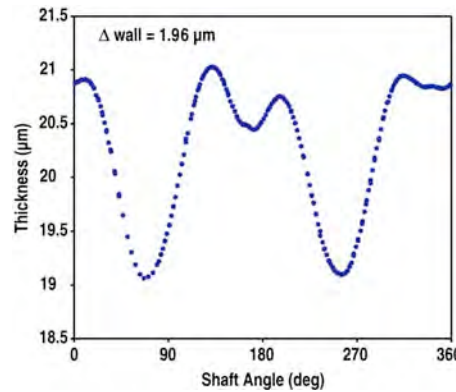

Wallmapper results.



Shell with specified P2 shape

Absorption Edge Spectroscopy (Edge)

We developed the Edge method to measure the areal density of any element with an atomic number $Z > 17$. It does not suffer the matrix effect as in XRF and requires no reference standard to achieve $\pm 3\%$ $1\text{-}\sigma$ accuracy. This method is applicable to a variety of Inertial Confinement Fusion (ICF) and High Energy Density (HED) targets. It also provides calibration and validation to other dopant profiling tools.

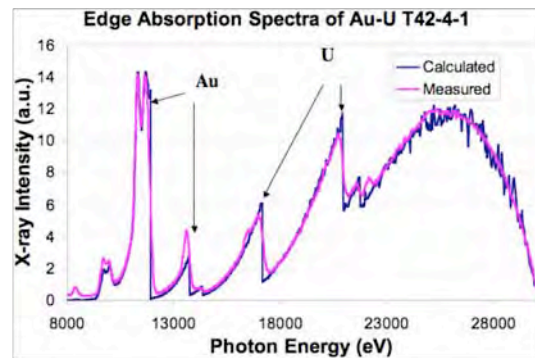
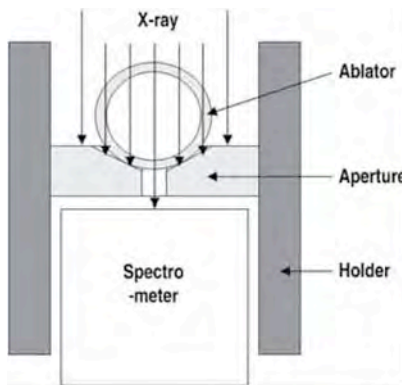

Precision Radiography

We designed and constructed a precision radiography system to measure x-ray opacity variation in an ablator capsule to 10^{-4} accuracy at $120\ \mu\text{m}$ spatial resolution. Recent improvement in x-ray tube design enables us to complete full-surface measurement in 1 day. This instrument is unique in its ability to see not only the surface perturbations but also the variations caused by nonuniformity of the dopant layers. Our innovative design allows us to bypass the counting saturation problem associated with CCD systems and to overcome the 10^{-3} long-term system drifts in order to achieve unprecedented measurement accuracy.

Phase Shifting Diffraction Interferometer (PSDI)

Commercial interferometers are geared to measure flat surfaces or curved surfaces with very large radius of curvatures. They cannot effectively measure 2 mm ablator capsules. On the other hand, NIF ignition campaign requires 100% of the capsules be inspected for defects. Based on the development work carried out by LLNL, a PSDI was designed and built which combines the automated motion control and a Twyman Green-type interferometer to map the entire shell surface in ~110 images. The resulting height map has a sensitivity of ~2 nm and a spatial resolution of ~1 μm . We developed custom software to batch process the images in order to retrieve surface roughness, power spectra, and point defect statistics. With the automation, a shell surface can be completely mapped in a few hours to NIF specification. The instrument can also measure the interior surface of a shell fragment.

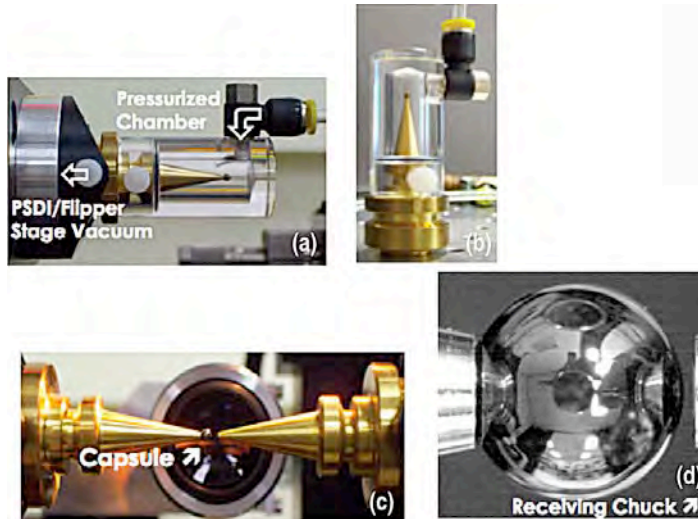

Snapshots of capsule on (a) PSDI stage, (b) N₂ pressurized transfer chamber, (c) PSDI Shell Flipper, and (d) closeup (gravity acts downward in each image).

Xradia Wallmapper (Transparent and Opaque Capsules)

We developed a 3D wallmapping capability based on a commercial Xradia MicroXCT x-ray microscope to measure the wall thickness of samples that cannot be measured with our optical wallmapper. These samples include opaque samples such as beryllium shells, low reflectivity samples such as foam shells, and multiple-layered shells such as the NIF point design shells. The method has a 0.3 μm measurement precision and, through phase contrast calibration, can achieve 0.3 μm accuracy.

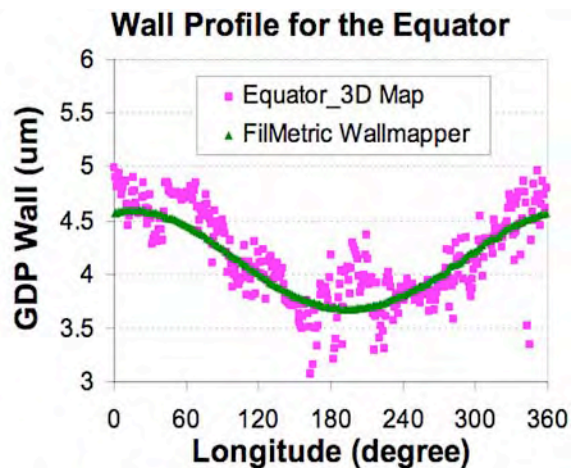

Comparison of Xradia and Filmetric Wallmapper results on the same sample shell.

FTIR Spectroscopy

A Nicolet Nexus FTIR spectrometer is used to measure the transmission of a flat witness foil to reveal the composition of a similarly produced shell. This is most often used to quantify oxygen pickup in shells and to determine how much air exposure is acceptable in processing and after delivery.

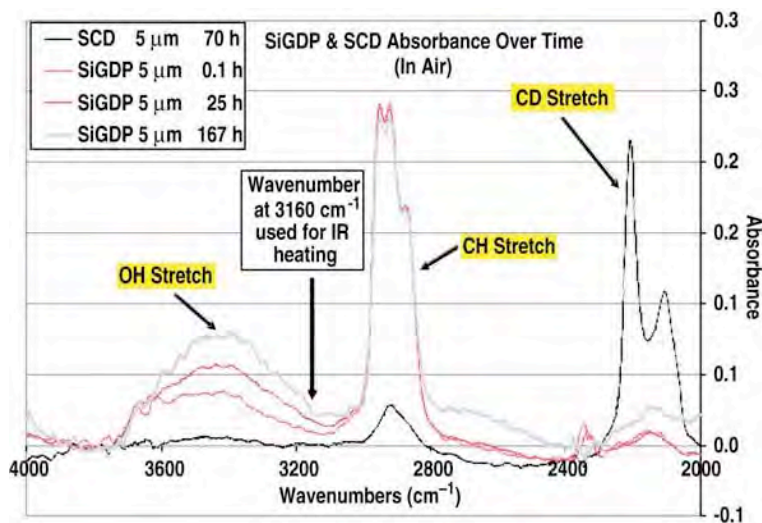

FTIR absorption data for oxygen pickup in Si-GDP and strong CD.

Densitometry

A gradient density column with NIST-traceable floats is used to measure the density of capsule materials.

Auger Spectroscopy

A Physical Electronics auger spectrometer is implemented for the elemental analysis of thin films and elemental depth profiling of target components to depths over 1-2 μm.

Scanning Electron Microscopy with EDX

A JEOL scanning electron microscope and an Oxford INCA EDX are combined to evaluate samples to 10,000X magnification. Surface morphology and element composition are measured at the submicron level.

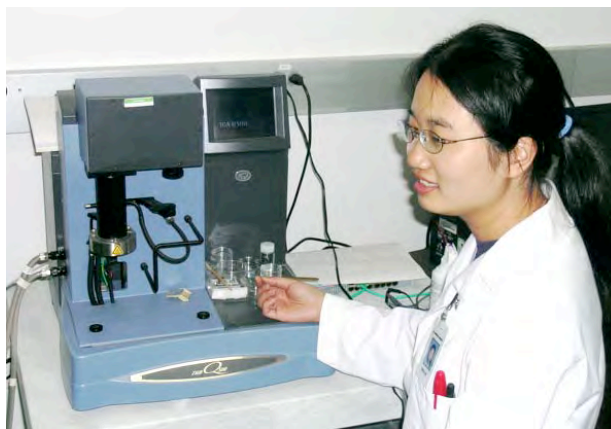

Thermogravimetric Analysis (TGA)

The pyrolysis of target material and processes are studied, e.g., converting Si-GDP shells to SiO₂ shells, using TGA methods.

Ellipsometry

Spectroscopic ellipsometry can be used to characterize thin film thickness to 1 nm precision. Variations in coating thicknesses of <1% on a 100 nm film can be measured reliably.



Ellipsometer used to measure pinhole free thin films

Gas and H₂O Permeability

We have facilities to measure the permeability of capsules for various gases including He, D (²H), N, Ar, Xe, and Kr. Measurement techniques include: weight loss, mass spectroscopy, and burst testing; and selection depends on the predicted leak rate as well as the customer needs. Gas filling can be performed from 25° – 100°C and facilities are onsite to characterize capsules with half-lives of several minutes to multiple days.

Facilities to conduct water permeation studies on thick as well as thin films are available. The measurement of slow leak rates, ranging from 10^{-2} – 10^{-6} (g/m² per day) can be performed. Current hardware allows samples to range from 1 inch diameter rounds up to 4 x 4 in. squares, and custom hardware can be developed to meet specific customer requirements. Extended leak rate monitoring (on the order of months) is available.

9. PRECISION TARGET ASSEMBLY

GA IFT has been involved in assembly activities for ICF since 1991. The assembly activities are broken into those performed onsite at the national labs and LLE and those performed on-site at GA. Directly or through its subcontractors, GA supplied trained and qualified assembly personnel for work on-site at LLNL and LANL as well as at LLE. These assembly activities have been crucial to the ICF effort and GA assemblers at LLNL have won several awards.

On-site assembly activities at GA are largely and specifically geared towards NIF targets. GA assembles complicated double-shell targets as well as a host of other targets for OMEGA experiments as needed. One major NIF assembly effort involves capsule fill tube assembly (CFTA) for current NIF targets, which was transferred to GA in 2006 and has been transferred to production by continuing the development to transform the process into a robust reproducible one. CFTA's are now produced by assembling 10 to 30 μm o.d. drilled holes in high density carbon (HDC) shells with 1400 to 2500 μm o.d., all of which are needed for NIF target development and experiments. After assembly, the CFTA undergoes leak testing, pressure testing, and x-ray fluorescence measurement for validation prior to shipping, all of which were fully developed at GA in collaboration with LLNL.

The CFTA station has three two-axis micromanipulators, two Sony XCD cameras, stereoscope, two goniometers, a nitrogen purge system, an oxygen analysis system, a vacuum system to seat the fill tube during attachment, helium adapters for leak testing, and numerous other fittings and equipment required for assembly and testing.

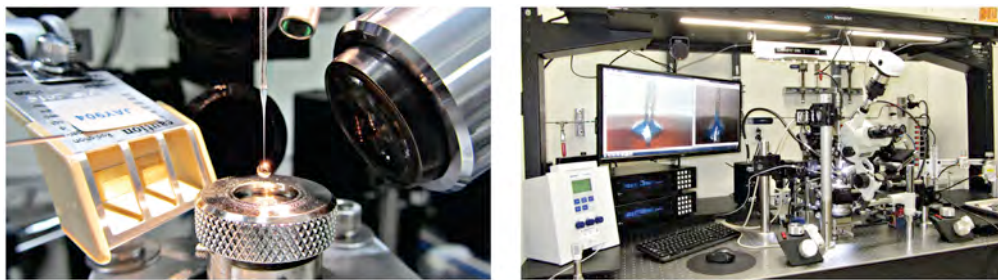

NIF Capsule Fill Tube Assembly Station



Fabrication of CFTA target.

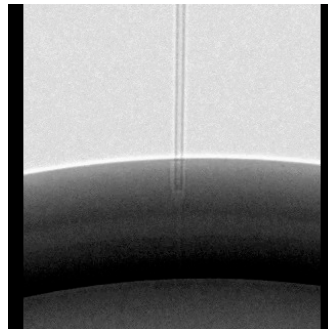

X-ray image of 10 μm fill tube inserted to 12 μm laser drilled hole in a capsule wall.

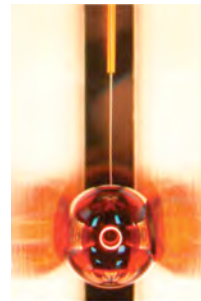

GDP Capsule



Be Capsule

Plastic and Be capsule fill tube assemblies (CFTA).

Another assembly built by GA is the thermal mechanical package (TMP) subassembly, which is used in current NIF targets. The current NIF target design requires a thermal package on the outside of the hohlraum. This thermal package is the transition point for the silicon cooling arms to hold the target and provides for the heaters and sensors. A detailed procedure was developed for this critical assembly at GA in close collaboration with LLNL and turned into a production process with dedicated personnel. In the assembly laboratory, a heater is wrapped around the aluminum can, and the aluminum can is precision mated to the silicon arm and bonded. Sensors and heaters are installed and, finally, the wiring harness attached. The electronic connections are verified using custom-built, automated LabView-driven testing.



NIF ignition target which includes TMP subassembly.



TMP subassembly.



Electrical testing of TMP subassembly.

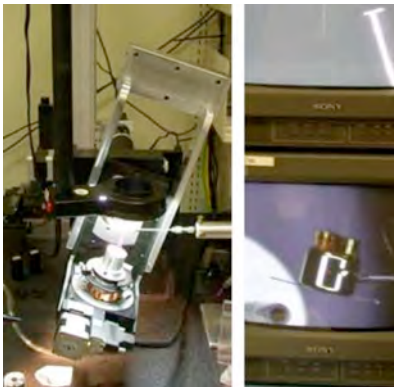

Assembly station in use at SNL.

GA-BUILT DUAL THETA ASSEMBLY/ CHARACTERIZATION STATION

In 2004, GA built a dual theta assembly/characterization at SNL using commercially available equipment to support SNL experiments on Omega. The system has two fixed cameras that define a three dimensional "area of interest." There are two positioners controlled by computerized micromanipulators that can move in x, y, z and rotate with 75 μm and 0.1 deg control. The software has edge detection and the ability to import CAD overlays for ease of assembly and sub-micron characterization

of as-built conditions for targets. A GUI interface was programmed to match the alignment within the Omega chamber so the target can be rotated to the desired view and pictures taken to assist the experimenter when aligning at Omega. While the system was built for Omega targets, its "area of interest" has proven to be large enough to be useful for larger targets such as those used at Z and could delete be used for NIF-type targets. Recently, GA duplicated this system and put it into service in San Diego.

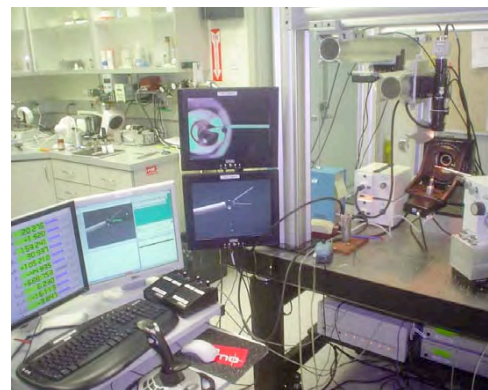

Operational assembly station at GA.

10. ADDITIVE MANUFACTURING

Sometimes referred to as 3D printing, additive manufacturing is more properly understood as encompassing a variety of manufacturing processes. In AM, objects are created by precisely adding layer-upon-layer of material according to a specific design, whether the material is plastic, metal, ceramic, or something else. AM has rapidly become widely utilized tool because of its ability to create geometries and features that are difficult or impossible to achieve through traditional methods such as machining, especially when creating very small objects.

General Atomics' Inertial Fusion Technologies division employs a specific AM method known as two-photon-polymerization (2PP), among other techniques, in its target manufacturing activities. In 2PP, focused, ultrashort laser pulses are directed into a volume of photosensitive material, or photoresist. The laser pulses cause polymerization in the photoresist, and by illuminating a specific three-dimensional region, solid structures can be created and remain behind when the unilluminated material is washed out. The name comes from the specific chemical reaction, which involves polymerization through absorption of two photons at time. 2PP is capable of creating ultra-high resolution features on the order of $\leq 1 \mu\text{m}$. GA has developed 2PP technology that can produce faster results with fewer defects over larger regions than competing methods.

Fabrication of Unique Parts Unable to be Made Any Other Way

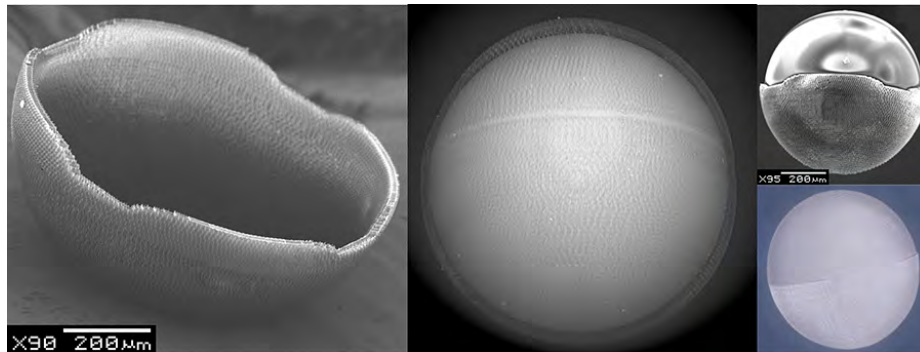

Thin Wall Foam Hemi Mounted on Direct Drive Capsule

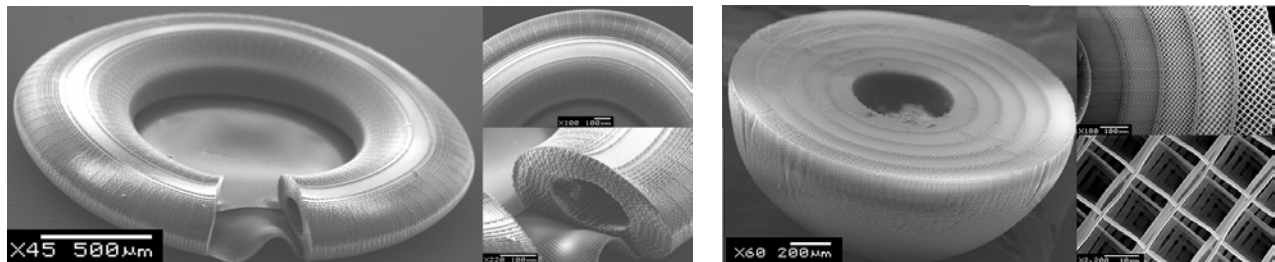

Gradient Density Foams in Spherical Geometries

ADDITIVE MANUFACTURED TARGETS



Stochastic Foams

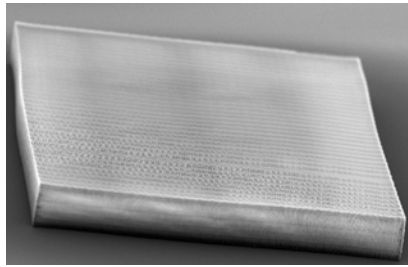

Planar Gradient Density foam

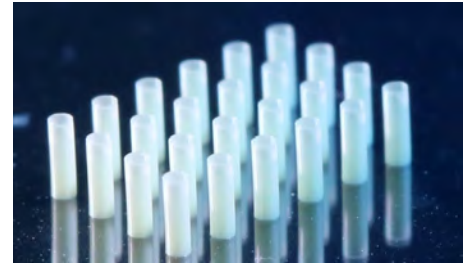

Batch Fabrication of Parabolic Cones in Tubes

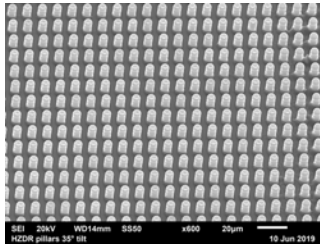

Micro Pillar Array

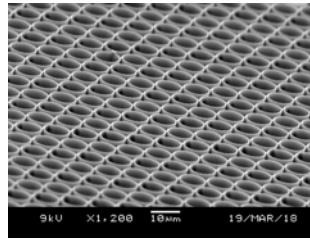

Micro Tube Array

GA also employs a similar, low temperature technique for 3D printing at high resolution (sub-micron) scale of pure metal features directly onto substrates. Even a delicate substrate such as few micron thick polypropylene films may be written upon. We can write using such elements as gold and silver.

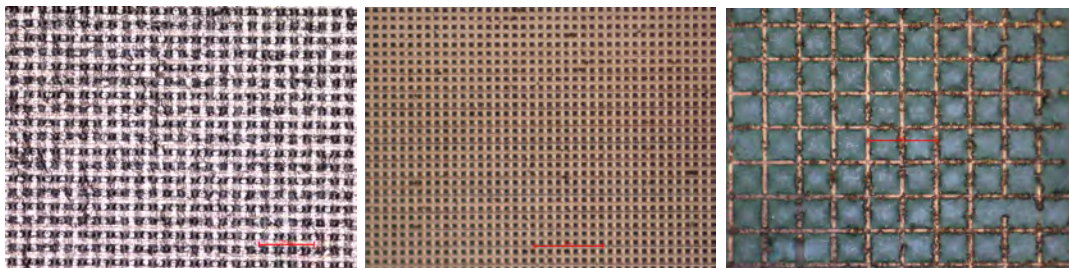

GA 3D printed metal grids in silver (L, C) and gold (R). The individual strands are approximately 2 μm thick

GA is currently developing technology to print pure carbon-hydrogen elements at sub-micron scale. This will be applied to advance GA IFT's world leading target fabrication capabilities among other efforts.

Resolution	200 nanometer
Print Volume	200mm x 200mm x 65mm
Print Speed	Up to 250mm/s
Materials (Obtained Directly or Through Post Processing)	Acrylic Plastic, CH Plastic, Doped Plastics, Gold, Copper, Platinum, Metal Oxides, Glass/Ceramics

For more information about our products, visit www.ga.com/inertial-fusion/

